



Technical Guidelines

# TECEfloor

Universal panel UP 16/12  
Dry-wall panel TP 30/16

16x2

TECE



## Table of contents



### Universal panel UP 16/12

Technical drawing explanations. ....	6
Product data sheets .....	7
Detailed information .....	10
Designs .....	13
Performance tables .....	24
Assembly instructions .....	32
Ultrabond Eco Fix UP .....	35

### Dry-wall panel TP 30/16

Product data sheets .....	37
Designs .....	38
Performance tables .....	40
Assembly instructions .....	48



- 1 Tile
- 2 Insulation mat 5 mm
- 3 System adhesive
- 4 Universal panel + system pipe
- 5 Edge board 16 mm
- 6 Edge insulation strips
- 7 System adhesive

Installation height: 21 mm incl. top floor

## TECEfloor UNIVERSAL PANEL 16/12

The universal panel 16/12 is particularly suitable for restricted installation heights for integration in the floor, on the wall and under the ceiling. This is possible thanks to the low element height of just 16 mm and using a 12 x 1.5 mm heating pipe.

The extremely low installation provides optimum controllability of the system.





"Low installation heights are often a problem when retrospectively installing underfloor heating. Additionally, many building clients shy away from the construction effort involved in laying screed. A flat dry-wall construction system can impress here."



TECEfloor universal panel 16/12 with prefabricated parquet laid floating. Total construction including floor covering: 33 mm.

- 1 Prefabricated parquet  $\geq 15$  mm
- 2 Universal panel + system pipe
- 3 Edge board
- 4 Edge insulation strips
- 5 System adhesive

## For restricted installation heights

In old buildings and during renovation in particular, installations of underfloor heating often go wrong due to the low installation height. Wooden joist ceilings also lead to an additional static problem: Conventional systems with wet screed quickly weigh more than  $100 \text{ kg/m}^2$ . The TECEfloor universal panel 16/12 can score twice here: It's extremely flat and direct laying makes it just as light.

### Product features

- Extra flat, just 16 mm – low installation heights
- Only two individual components – simple handling and processing
- Optimised panel dimensions – reduced storage
- Extremely high compression strength  $>200 \text{ KPa}$  makes extra-flat special structures possible – ideal for renovation
- Compatible system for floor, wall and ceiling – universal application
- Aluminium profiles glued on in the factory – quick assembly
- Predetermined breaking points – simple processing

## Technical drawing explanations

	Use in the floor		Dead/material weight (kg/m <sup>2</sup> ) including surface
	Use in the wall		Permissible payload (q <sub>k</sub> )
	Use in ceiling		Permissible individual load (Q <sub>k</sub> ) → Supporting surface ≥ 20 cm <sup>2</sup>
	Use in heating		Flat, smooth and load-bearing subsurface required (higher requirements in accordance with DIN 18202 tab. 3, row 4)
	Use in cooling		Wooden joist ceilings must be torsionally rigid and free of deflection
	Surface thickness		Building waterproofing in accordance with DIN 18195
	Tile size		Glue system elements/material layers together over the complete surface
	Joint size		Filling for compensation not permitted
	Thermal output in accordance with DIN EN 1264		Lay tiles in combined process with MAPEI adhesive Elastorapid and joint mortar Ultracolor Plus
	Maximum surface temperature (°C)		Thermal insulation
	Thermal resistance (R)		Additional insulation
	Heat transfer coefficient (U)		Important information
	Impact sound improvement (dB)		Further information

### Application area A: Residential areas



EN 1991	EN 1991/NA	SIA 261
✓ <b>A</b> : Rooms in residential buildings, hotel rooms, wards	✓ <b>A2 A3</b> : Rooms in residential buildings, hotel rooms	✓ <b>A1</b> : Rooms in residential buildings, hotel rooms, wards

### Application area B: Office and working areas



EN 1991	EN 1991/NA	SIA 261
✓ <b>B</b> : Office areas	✓ <b>B1</b> : Office areas, doctor's practices, wards	✓ <b>D1</b> : Sales areas up to 50 m <sup>2</sup> Base area
		✓ <b>B1</b> : Office areas

### Application area C: Assembly and sales areas



EN 1991	EN 1991/NA	SIA 261	EN 1991	EN 1991/NA	SIA 261	EN 1991/NA	EN 1991/NA	SIA 261
✓ <b>C1 C3</b>	✓ <b>C1 C3</b>	✓ <b>C1 C2</b>	✓ <b>D1</b>	✓ <b>D2</b>	✓ <b>D</b>	✓ <b>E1</b>	✓ <b>B2 B3</b>	✓ <b>C3</b>
Areas in churches, theatres or cinemas, congress rooms, lecture theatres, waiting rooms, museum areas, exhibition areas, entrance areas in public buildings and hotels			Areas in retail stores and department stores			Factories and workshops with light operation	Concert halls, treatment and operation rooms	Sports and games areas



## TECEfloor universal panel FM 16/12

### Product data

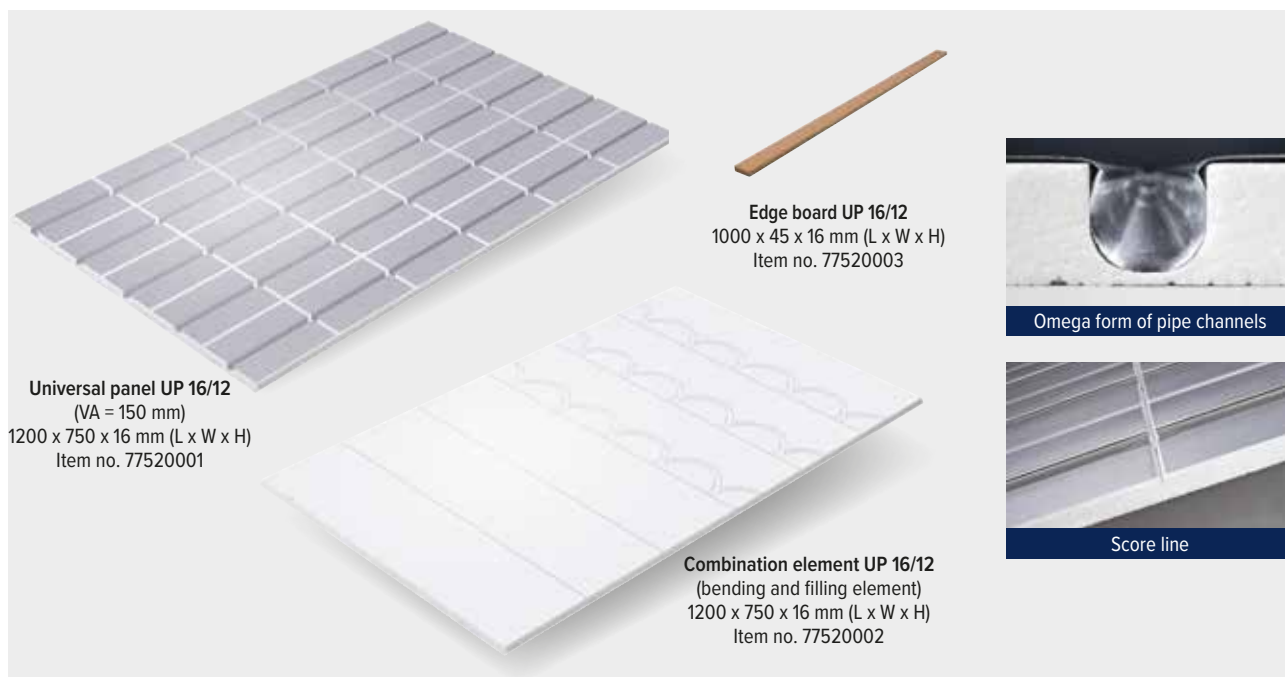

<b>Material</b>	Base plate	Polystyrene plate EPS 035 DE0; 240 kPa
	Heat conducting plate	Aluminium 0.25 mm, with pipe guides (Omega form), flanged
<b>Data</b>	Thermal conductivity	0.035 W/mK
	Thermal resistance	0.40 m <sup>2</sup> K/W
	Compression strength	240 kPa at 10 % compression in accordance with DIN EN 826
	Fire behaviour	Euroclass E as per DIN EN 13501-1
	Tube diameter	ø 12 mm

<b>Prerequisite in accordance with DIN 18202</b>		Inside micrometers as limit values in mm for measuring point intervals in m				
		0.1 m	1 m	4 m	10 m	15 m
4	Ready-to-cover floors with higher requirements, e.g. with self-levelling fillers	1 mm	3 mm	9 mm	12 mm	15 mm

<b>Accessories</b>	<b>Product</b>	<b>Type</b>	<b>L x W x H</b>	<b>Item no.</b>
	Edge insulation strip	TECEfloor	40 m x 10 mm x 150 mm	77620012
	SLQ PE-RT 5S floor heating pipe	TECEfloor	12 x 1.5 mm	77111220



## Load distribution and insulation mat

### Product data



**Insulation mat UP**  
1150 x 600 x 5 (+0.5) mm (L x W x H)  
Item no. 77520018





High proportion of aluminium



Load distribution layer for tiles



Load distribution layer for laminate

<b>Material</b>	Base plate	Polyester-fibre plate made of aluminium-clad polyester fleece and thermoplastic binder based on styrene acrylic with high tear resistance and compression strength	
<b>Data</b>	Weight	5.2 kg/m <sup>2</sup> ± 5 %	
	Thermal conductivity	0.2 W/mK	
	Humidity resistance	Rot-proof	
	Vapour diffusion resistance factor	approx. 30 μ	
	Coefficient of linear expansion	2.75 x 10 (exp -5) 1/K	
	Thickness increase under effect of temperature (100h, 80°C)	< 0.3 mm	
	Thickness increase under effect of water (80h, 23°C)	< 0.5 mm	
	Fire behaviour in accordance with DIN EN 13501-1	E(f)	
	Impact sound improvement with ceramic top covering (test stand value in accordance with DIN ISO 140-8:1998, used as a guide)	14 dB with TECEfloor universal panel UP	
	Field size	Max. 60 m <sup>2</sup> , length and width ratio max. 2:1	
	Waste code	170701	
<b>Material releases</b>	Tile formats	Minimum size: 10 x 10 cm or 100 cm <sup>2</sup> , maximum size: 80 x 80 cm, minimum thickness (natural stone): 15 mm	
	Joint sizes	Tile format up to 30 x 30 cm = min. 3 mm, 40 x 40 cm = min. 4 mm, 80 x 80 cm = min. 5 mm	
	Tile adhesive	Mapei Elastorapid or similar	
	Joint mortar	Mapei Ultracolor Plus or similar	
	Fixing on heating elements (with tile layer)	Mapei Ecofix or similar	
<b>Accessories</b>	<b>Product</b>	<b>Type</b>	<b>Item no.</b>
	 Joint adhesive strip for load distribution and insulation mat	120 m	77520019
	 Ultrabond Eco Fix UP	10 kg	77520020



## Hot cutter UP

### Product data



Hot cutter UP  
Item no. 77520021



Easy to operate



Precise pipe grooves (16 mm)

### Data

Type	SC-11
Operating voltage	230 V ~ 50-60 Hz
Power consumption	60 W
Intermittent service	12s ON   48s OFF
Weight	1025 g
CE mark	Meets the requirements of EU directives: 2004/108/EC and 2006/95/EC

























For further information, see the operating instructions.



## Additional insulation with UP 16/12

### Detailed information

	 ≤ 1.0 kN*		 ≤ 2.0 kN / m <sup>2</sup>		Category		 EN 1991	 EN 1991NA	 SIA 261
					-	-		-	-
Load distribution layer	Insulation mat (tiles)	Insulation mat + laminate	Parquet	Floorboards on floor battens	Fermacell	Fermacell	ESTRICHZIEGEL		
Thickness	5 mm	5 + 8 mm	15 mm	20-22 mm	20 mm	25 mm	20 mm		
EPS DEO 200 kPa WLG 035	max. 20 mm	max. 20 mm	max. 20 mm	max. 40 mm	max. 70 mm	max. 90 mm	max. 130 mm		
max. layers	1	1	1	1	2	2	2		
XPS DEO 300 kPa WLG 035	max. 30 mm	max. 30 mm	max. 30 mm	max. 50 mm	max. 70 mm	max. 90 mm	max. 140 mm		
max. layers	1	1	1	1	2	2	3		
XPS DEO 500 kPa WLG 035	max. 60 mm	max. 60 mm	max. 60 mm	max. 80 mm	max. 100 mm	max. 120 mm	max. 190 mm		
max. layers	1	1	1	2	2	2	3		
Wood fibre insulation 150 kPa	max. 20 mm	max. 20 mm	max. 20 mm	max. 60 mm	max. 40 mm	max. 50 mm	max. 100 mm		
max. layers	1	1	1	1	1	1	2		
plus 12.5 mm load distribution sheet	required	required	required						
Levelling screed	not possible	Additional insulation / fill > 30 mm: Subtraction of fill thickness from max. insulation thickness							
plus 12.5 mm load distribution sheet	not possible	required → if no additional insulation is used							

	 ≤ 2.0 kN*		 ≤ 2.0 kN / m <sup>2</sup>		Category		 EN 1991	 EN 1991NA	 SIA 261
						-			
Load distribution layer	Insulation mat (tiles)	Insulation mat + laminate	Parquet	Floorboards on floor battens	Fermacell	Fermacell	ESTRICHZIEGEL		
Thickness	5 mm	5 + 8 mm	15 mm	20-22 mm	20 mm	25 mm	20 mm		
EPS DEO 200 kPa WLG 035	max. 20 mm	max. 20 mm	max. 20 mm	max. 40 mm	max. 70 mm	max. 90 mm	max. 130 mm		
max. layers	1	1	1	1	1	2	2		
XPS DEO 300 kPa WLG 035	max. 30 mm	max. 30 mm	max. 30 mm	max. 40 mm	max. 70 mm	max. 90 mm	max. 140 mm		
max. layers	1	1	1	1	2	2	3		
XPS DEO 500 kPa WLG 035	max. 60 mm	max. 60 mm	max. 60 mm	max. 60 mm	max. 100 mm	max. 120 mm	max. 190 mm		
max. layers	1	1	1	2	1	2	3		
Wood fibre insulation 150 kPa	-	max. 20 mm	max. 20 mm	max. 20 mm	-	max. 40 mm	max. 80 mm		
max. layers		1	1	1		1	2		
plus 12.5 mm load distribution sheet		required	required						
Levelling screed	not possible	Additional insulation / fill > 30 mm: Subtraction of fill thickness from max. insulation thickness							
plus 12.5 mm load distribution sheet	not possible	required → if no additional insulation is used							

\*Individual load (Q<sub>k</sub>): Supporting surface min. 20 cm<sup>2</sup>, max. deformation < 3 mm; particularly heavy objects (aquariums, bathtubs) must be considered separately



## Requirements for the load-bearing subsurface

Flat, smooth and load-bearing subsurface required → Flatness tolerances according to DIN 18202 Tab. 3



Line	Reference	Inside micrometers as limit values in mm for measuring point intervals in m				
		0.1 m	1 m	4 m	10 m	15 m
4	Ready-to-cover floors with higher requirements, e.g. with self-levelling fillers	1 mm	3 mm	9 mm	12 mm	15 mm



Wooden joist ceilings must be torsionally rigid and free of deflection

### Action recommendations dependent on height of unevenness

#### A Unevenness from 3 – 30 mm

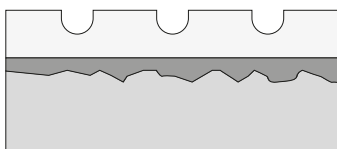

Universal panel UP  
Levelling compound 3 – 30 mm  
Raw floor

- Smooth finish with suitable plaster compound or levelling compound.
- Pre-treat bare floors as per manufacturer instructions if necessary.

#### B Unevenness from 10 - 50 mm or height adjustment

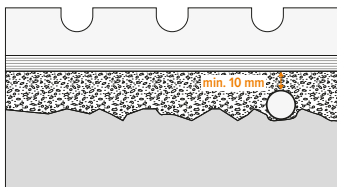

Universal panel UP  
Plasterboards (min. 10 mm)  
Fill  
Raw floor

- Fill with cover from 10 mm plasterboard.
- **Attention: not suitable for direct laying with insulation mat and tiles.**

#### C Unevenness from 30 mm and height adjustment

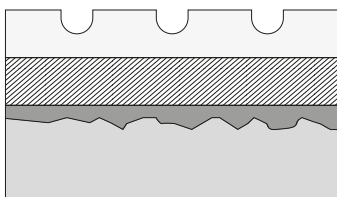

Universal panel UP  
XPS DEO plate\*  
Levelling compound 3 – 30 mm  
Raw floor

- Level unevenness with plaster or levelling compound.
- Height adjustment with XPS DEO plates.
- \***Caution: max. XPS construction heights see Additional insulation in dry-wall construction**

#### D Unevenness from 30 mm and height adjustment

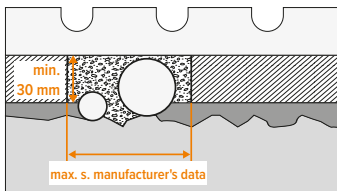

Universal panel UP  
XPS DEO plate\* (see C) with  
Fermacell-bound fill  
(at least 30 mm)  
Levelling compound 3 – 30 mm  
Raw floor

- Level unevenness with plaster or levelling compound.
- Height adjustment with XPS DEO plates.
- Compensate for pipe runs with bound fill.
- Please consider the manufacturer's instructions!

#### E Unevenness from 30 mm or height adjustment

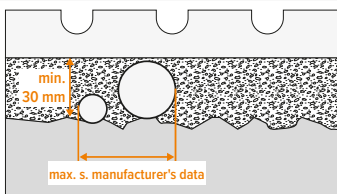

Universal panel UP  
Fermacell bound fill  
(at least 30 mm)  
Raw floor

- Fermacell bound fill
- Please consider the manufacturer's instructions!

## Material requirements

Quantities per m <sup>2</sup> , excluding leftovers!			RA 150
77111220	TECEfloor SLQ PE-RT 5S pipe	m	6.7
77520001	TECEfloor universal panel FM 16/12	m <sup>2</sup>	0.8
77520002	TECEfloor combination element FM 16/12	m <sup>2</sup>	0.2
77520003	TECEfloor edge board FM 16/12	m	1.1
77620012	TECEfloor edge insulation strip 10/150	m	1.1
77520018	TECEfloor insulation mat UP, see design type "DA"	m <sup>2</sup>	1.0
77520019	TECEfloor joint adhesive strip UP 120 m see design "DA 01" and "DA 02"	m	2.5
77520020	TECEfloor Ultrabond ECO FIX UP 10 kg, see design type "DA" and "DP"	kg	approx. 0.125 kg/m <sup>2</sup> per adhesive layer
77520021	TECEfloor hot cutter UP		

## Installation times

Practical empirical values for installation times (no guarantee can be given for these times).	1 person
UP 16/12 (edge insulation strip, system elements, pipe)	12 min/m <sup>2</sup>
Laying of insulation mat	8 min/m <sup>2</sup>
Application of adhesive per layer	0.5 min/m <sup>2</sup>
Application of joint adhesive strip	0.5 min/m <sup>2</sup>

## Installation steps

- 1) Level unevenness (see detailed information), apply seal if necessary
- 2) Calculate room geometry and possible pipe guide, if necessary lay a few head pieces and boards as a test
- 3) Apply adhesive if necessary (see Designs)
- 4) Lay additional insulation if necessary (see Designs)
- 5) Position edge insulation strip
- 6) Lay edge boards
- 7) Apply adhesive if necessary (see Designs)
- 8) Universal panel UP 16/12
- 9) Cut in pipe guides with hot cutter
- 10) Lay pipe
- 11) Apply adhesive if necessary (see Designs)
- 12) Lay insulation mat if necessary (see Designs)
- 13) Apply joint adhesive strip if necessary (see Designs)
- 14) Lay surface or dry screed (see Designs)



## Designs



### TECEfloor universal panel FM 16/12

#### Direct laying (DA)

DA 01	Insulation mat UP   Tile .....	14
DA 02	Insulation mat UP   Tile (additional insulation) .....	15
DA 04	Insulation mat UP   Laminate .....	16
DA 05	Insulation mat UP   Laminate (additional insulation) .....	17

#### Direct laying parquet (DP)

DP 01	Direct laying parquet .....	18
DP 02	Direct laying parquet (additional insulation) .....	19

#### Dry screed 20 mm (TE20)

TE20 01	Dry screed element (Fermacell 20 mm) .....	20
TE20 02	Dry screed element (Fermacell 20 mm, additional insulation) .....	21

#### Dry screed 25 mm (TE25)

TE25 01	Dry screed element (Fermacell 25 mm) .....	22
TE25 02	Dry screed element (Fermacell 25 mm, additional insulation) .....	23



## Insulation mat UP | Tiles without additional insulation

### TECEfloor universal panel FM 16/12







Tiles  $\geq 10 \times 10 \text{ cm} \rightarrow \leq 80 \times 80 \text{ cm}$   
(Aspect ratio 1:1 to 3:1)



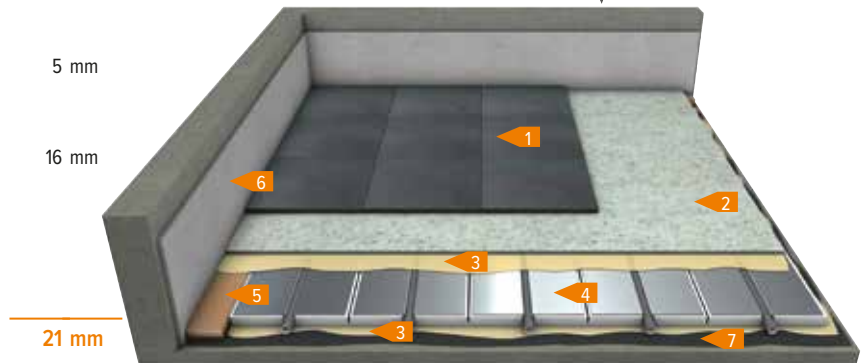







Joint width: Tile  $\leq 30 \times 30 \text{ cm} =$  at least 3 mm;  
 $\leq 40 \times 40 \text{ cm} =$  at least 4 mm;  $\leq 80 \times 80 \text{ cm} =$   
at least 5 mm







- 1** Tiles  $\geq 10 \text{ mm}$  | Natural stone  $\geq 15 \text{ mm}$
- 2** Insulation mat UP + joint adhesive strip
- 3** Adhesive (MAPEI ECO FIX)
- 4** Universal panel + system pipe
- 5** Edge board (16 mm), mandatory
- 6** Edge insulation strip
- 7** Moisture barrier if applicable (connection to subsurface)



	$> 0.40 \text{ m}^2\text{K/W}$	Minimum thermal resistance in accordance with DIN EN 1264 <b>not met</b>
		
	The carrier material EPS (DEO) is thermal insulation without defined impact sound insulation	

	$\sim 9 \text{ kg/m}^2$ Without floor covering
	$\leq 2.0 \text{ kN/m}^2$
	$\leq 2.0 \text{ kN}$ $\geq 20 \text{ cm}^2$

Category	 EN 1991	 EN 1991/NA	 SIA 261
	✓ A	✓ A2 A3	✓ A1
	-	✓ B1 D1	-
	-	-	-

	Flat, smooth and load-bearing subsurface required (higher requirements in accordance with DIN 18202 tab. 3, row 4)
	Wooden joist ceilings must be torsionally rigid and free of deflection $L/500 =$ at a support width of, for example, 5 m, the permissible deflection is 1 cm
	Fill (loose and bound) for compensation is not permitted
	Adhere system elements/additional insulation/material layers completely with each other and to the subsurface
	Lay tiles in combined process with MAPEI adhesive Elastorapid and joint mortar Ultracolor Plus
	The following insulation thicknesses are permitted for a payload of $(q_k) \leq 2.0 \text{ kN/m}^2$ and an individual load $(Q_k) \leq 2.0 \text{ kN}$ : Additional insulation EPS DEO 200 kPa max. 20 mm (max. one layer) Additional insulation XPS DEO 300 kPa max. 30 mm (max. one layer) Additional insulation XPS DEO 500 kPa max. 60 mm (max. one layer) Minimum thermal resistance in accordance with DIN EN 1264 met: · with 15 mm EPS 035 ( $R_{\lambda,ins} = 0.82 \text{ m}^2\text{K} / \text{W}$ ) for ceilings between rooms of the same temperature · with 30 mm XPS 035 ( $R_{\lambda,ins} = 1.25 \text{ m}^2\text{K} / \text{W}$ ) for ceilings against unheated rooms/ ground
	The specifications of the permissible individual load ( $Q_k$ ) relate to a load area of at least $20 \text{ cm}^2$ (compression die $\varnothing = 5 \text{ cm}$ ) Fill pipe runs to max. 30 cm with bound fill. From 10 cm width, cover with a 1 mm thick plate. For pipe runs 15 cm width and larger, a separate load distribution layer (at least 18 mm) is required on the additional insulation.

	<b>Thermal output: DA</b> See product data sheets and detailed information
---	---



## Insulation mat UP | Tiles with additional insulation

### TECEfloor universal panel FM 16/12

Tiles  $\geq 10 \times 10 \text{ cm} \rightarrow \leq 80 \times 80 \text{ cm}$   
(Aspect ratio 1:1 to 3:1)
   
  
 Joint width: Tile  $\leq 30 \times 30 \text{ cm} =$  at least 3 mm;  
 $\leq 40 \times 40 \text{ cm} =$  at least 4 mm;  $\leq 80 \times 80 \text{ cm} =$   
at least 5 mm

- 1** Tiles  $\geq 10 \text{ mm}$  | Natural stone  $\geq 15 \text{ mm}$
- 2** Insulation mat UP + joint adhesive strip
- 3** Adhesive (MAPEI ECO FIX)
- 4** Universal panel + system pipe
- 5** Edge board (16 mm), mandatory
- 6** Additional insulation XPS DEO, 300 kPa
- 7** Edge insulation strip
- 8** Moisture barrier if applicable (connection to subsurface)

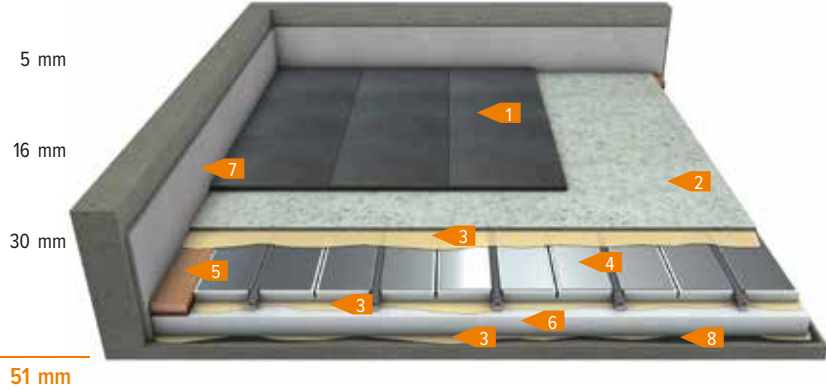

 <b>R</b>	$> 1.25 \text{ m}^2\text{K/W}$	Minimum thermal resistance (Ceilings against unheated rooms/ ground) met according to DIN EN 1264	 <b>~ 10 kg/m<sup>2</sup></b> <i>Without floor covering</i>	Category	 EN 1991	 EN 1991/NA	 SIA 261
 <b>U</b>			 $\leq 2.0 \text{ kN/m}^2$		✓ <b>A</b>	✓ <b>A2 A3</b>	✓ <b>A1</b>
 <b>The carrier material EPS DEO is thermal insulation without defined impact sound insulation</b>			 $\leq 2.0 \text{ kN}$ <i>* <math>\geq 20 \text{ cm}^2</math></i>		-	✓ <b>B1 D1</b>	-
					-	-	-

- Flat, smooth and load-bearing subsurface required (higher requirements in accordance with DIN 18202 tab. 3, row 4)
- Wooden joist ceilings must be torsionally rigid and free of deflection  
 $L/500 =$  at a support width of, for example, 5 m, the permissible deflection is 1 cm
- Building waterproofing in accordance with DIN 18195 exists under the concrete slab in structures against the ground, otherwise must be applied on the raw floor
- Fill (loose and bound) for compensation is not permitted
- Adhere system elements/material layers completely with each other and to the subsurface
- Lay tiles in combined process with MAPEI adhesive Elastorapid and joint mortar Ultracolor Plus
- The following insulation thicknesses are permitted for a payload of  $(q_k) \leq 2.0 \text{ kN/m}^2$  and an individual load  $(Q_k) \leq 2.0 \text{ kN}$ :  
Additional insulation EPS DEO 200 kPa max. 20 mm (max. One layer)  
Additional insulation XPS DEO 300 kPa max. 30 mm (max. One layer)  
Additional insulation XPS DEO 500 kPa max. 60 mm (max. One layer)
- The specifications of the permissible individual load  $(Q_k)$  relate to a load area of at least  $20 \text{ cm}^2$  (compression die  $\varnothing = 5 \text{ cm}$ )  
Fill pipe runs to max. 30 cm with bound fill. From 10 cm width, cover with a 1 mm thick plate.  
For pipe runs 15 cm width and larger, a separate load distribution layer (at least 18 mm) is required on the additional insulation.

**Thermal output: DA**  
See product data sheets and detailed information



## Insulation mat UP | Laminate without additional insulation

### TECEfloor universal panel FM 16/12

- 1 Laminate  $\geq 8$  mm
- 2 Insulation mat UP
- 3 Moisture barrier if applicable
- 4 Universal panel + system pipe
- 5 Edge board (16 mm), use recommended
- 6 Edge insulation strip
- 7 Adhesive, MAPEI ECO FIX

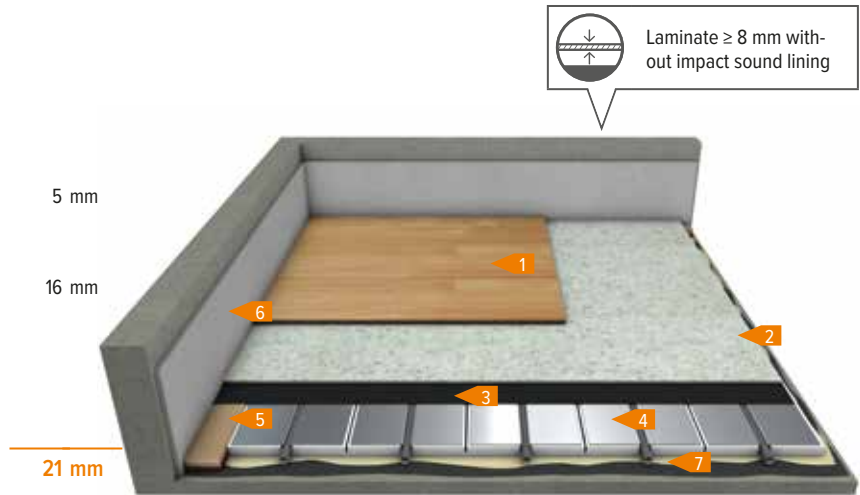

$> 0.40 \text{ m}^2\text{K/W}$	Minimum thermal resistance in accordance with DIN EN 1264 <b>not met</b>	$\sim 9 \text{ kg/m}^2$ Without floor covering	Category			
		$\leq 2.0 \text{ kN/m}^2$				
The carrier material EPS DEO) is thermal insulation without defined impact sound insulation		$\leq 2.0 \text{ kN}$ $\geq 20 \text{ cm}^2$		–		–
				–	–	–

$1\text{m}$ $\text{max. } 3\text{mm}$	Flat, smooth and load-bearing subsurface required (higher requirements in accordance with DIN 18202 tab. 3, row 4)
	Wooden joist ceilings must be torsionally rigid and free of deflection $L/500 =$ at a support width of, for example, 5 m, the permissible deflection is 1 cm
	Adhere system elements/additional insulation/material layers completely with each other and to the subsurface
	The following insulation thicknesses are permitted for a payload of $(q_k) \leq 2.0 \text{ kN/m}^2$ and an individual load $(Q_k) \leq 2.0 \text{ kN}$ : Additional insulation EPS DEO 200 kPa max. 20 mm (max. one layer) Additional insulation XPS DEO 300 kPa max. 30 mm (max. one layer) Additional insulation XPS DEO 500 kPa max. 60 mm (max. one layer) Minimum thermal resistance in accordance with DIN EN 1264 met: · with 15 mm EPS 035 ( $R_{\lambda, \text{ins}} = 0.82 \text{ m}^2\text{K/W}$ ) for ceilings between rooms of the same temperature · with 30 mm XPS 035 ( $R_{\lambda, \text{ins}} = 1.25 \text{ m}^2\text{K/W}$ ) for ceilings against unheated rooms/ ground
	The specifications of the permissible individual load ( $Q_k$ ) relate to a load area of at least $20 \text{ cm}^2$ (compression die $\varnothing = 5 \text{ cm}$ ) Fill pipe runs to max. 30 cm with bound fill. From 10 cm width, cover with a 1 mm thick plate. For pipe runs 15 cm width and larger, a separate load distribution layer (at least 18 mm) is required on the additional insulation.

**Thermal output: DA**  
See product data sheets and detailed information



## Insulation mat UP | Laminate with additional insulation

### TECEfloor universal panel FM 16/12

- 1** Laminate ≥ 8 mm
- 2** Insulation mat UP
- 3** Universal panel + system pipe
- 4** Adhesive, MAPEI ECO FIX
- 5** Edge board (16 mm), use recommended
- 6** Additional insulation XPS DEO, 300 kPa
- 7** Edge insulation strip
- 8** Moisture barrier if applicable (connection to subsurface)

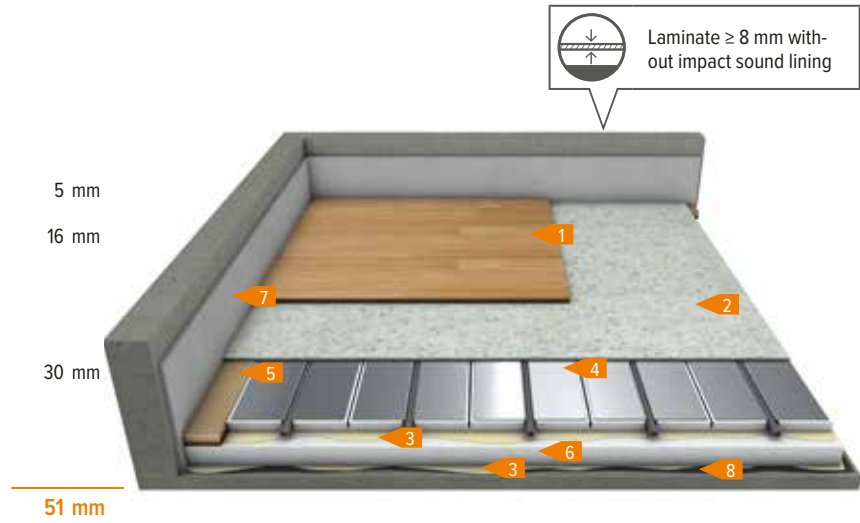

$> 1.25 \text{ m}^2\text{K/W}$	Minimum thermal resistance (Ceilings against unheated rooms/ ground) met according to DIN EN 1264	$\sim 10 \text{ kg/m}^2$ Without floor covering
		$\leq 2.0 \text{ kN/m}^2$
The carrier material EPS DEO is thermal insulation without defined impact sound insulation		$\leq 2.0 \text{ kN}$ $\geq 20 \text{ cm}^2$

Category	EN 1991	EN 1991/NA	SIA 261
	✓ A	✓ A2 A3	✓ A1
	-	✓ B1 D1	-
	-	-	-

1m over 3mm	Flat, smooth and load-bearing subsurface required (higher requirements in accordance with DIN 18202 tab. 3, row 4)
	Wooden joist ceilings must be torsionally rigid and free of deflection $L/500 =$ at a support width of, for example, 5 m, the permissible deflection is 1 cm
	Building waterproofing in accordance with DIN 18195 exists under the concrete slab in structures against the ground, otherwise must be applied on the raw floor
	Adhere system elements/material layers completely with each other and to the subsurface
	The following insulation thicknesses are permitted for a payload of $(q_k) \leq 2.0 \text{ kN/m}^2$ and an individual load $(Q_k) \leq 2.0 \text{ kN}$ : Additional insulation EPS DEO 200 kPa max. 20 mm (max. One layer) Additional insulation XPS DEO 300 kPa max. 30 mm (max. One layer) Additional insulation XPS DEO 500 kPa max. 60 mm (max. One layer)
	The specifications of the permissible individual load $(Q_k)$ relate to a load area of at least $20 \text{ cm}^2$ (compression die $\varnothing = 5 \text{ cm}$ ) Fill pipe runs to max. 30 cm with bound fill. From 10 cm width, cover with a 1 mm thick plate. For pipe runs 15 cm width and larger, a separate load distribution layer (at least 18 mm) is required on the additional insulation.

Thermal output: DA  
See product data sheets and detailed information



## Direct laying of parquet without additional insulation

### TECEfloor universal panel FM 16/12

- 1 Parquet  $\geq 15$  mm (floating)
- 2 Impact sound insulation strip
- 3 Moisture barrier if applicable
- 4 Universal panel + system pipe
- 5 Edge board (16 mm), use recommended
- 6 Edge insulation strip
- 7 Adhesive (MAPEI Ecofix)

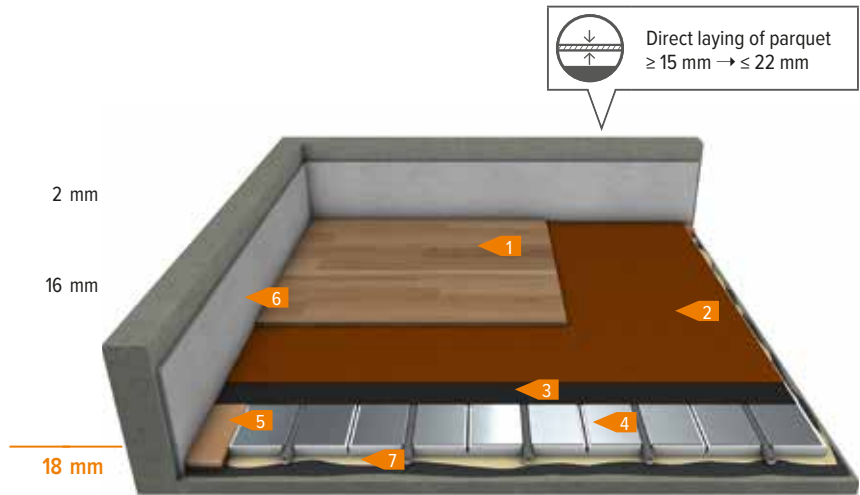

	$> 0.40 \text{ m}^2\text{K/W}$	Minimum thermal resistance in accordance with DIN EN 1264 <b>not met</b>
	14 dB	Test value in accordance with DIN ISO 140-8; applies for concrete ceilings $> 12$ cm (DIN 4109: $\text{m}^2 > 276 \text{ kg/m}^2$ )

	$\sim 5 \text{ kg/m}^2$	Without floor covering
	$\leq 2.0 \text{ kN/m}^2$	
	$\leq 2.0 \text{ kN}$	$\geq 20 \text{ cm}^2$

Category	EN 1991	EN 1991/NA	SIA 261
	✓ A	✓ A2 A3	✓ A1
	-	✓ B1 D1	-
	-	-	-

	Flat, smooth and load-bearing subsurface required (higher requirements in accordance with DIN 18202 tab. 3, row 4)
	Glue system elements to the subsurface over the complete surface
	<p>The following insulation thicknesses are permitted for a payload of <math>(q_k) \leq 2.0 \text{ kN/m}^2</math> and an individual load <math>(Q_k) \leq 2.0 \text{ kN}</math>:</p> <ul style="list-style-type: none"> <li>Additional insulation EPS DEO 200 kPa max. 20 mm (max. one layer)</li> <li>Additional insulation XPS DEO 300 kPa max. 30 mm (max. one layer)</li> <li>Additional insulation XPS DEO 500 kPa max. 60 mm (max. one layer)</li> </ul> <p>Minimum thermal resistance in accordance with DIN EN 1264 met:</p> <ul style="list-style-type: none"> <li>with 15 mm EPS 035 (<math>R_{\lambda, \text{ins}} = 0.82 \text{ m}^2\text{K/W}</math>) for ceilings between rooms of the same temperature</li> <li>with 30 mm XPS 035 (<math>R_{\lambda, \text{ins}} = 1.25 \text{ m}^2\text{K/W}</math>) for ceilings against unheated rooms/ ground</li> </ul>
	<p>The specifications of the permissible individual load (<math>Q_k</math>) relate to a load area of at least <math>20 \text{ cm}^2</math> (compression die <math>\varnothing = 5 \text{ cm}</math>)</p> <p>If necessary, protect surface against moisture from below in accordance with manufacturer instructions (vapour barrier)</p>

	<p>Thermal output: DP</p> <p>See product data sheets and detailed information</p>
--	---



## Direct laying of parquet with additional insulation

### TECEfloor universal panel FM 16/12

- 1 Parquet ≥ 15 mm (floating)
- 2 Impact sound insulation strip
- 3 Universal panel + system pipe
- 4 Edge board (16 mm), use recommended
- 5 Additional insulation XPS DEO, 300 kPa
- 6 Edge insulation strip
- 7 Adhesive (MAPEI Ecofix)
- 8 Moisture barrier if applicable (connection to subsurface)

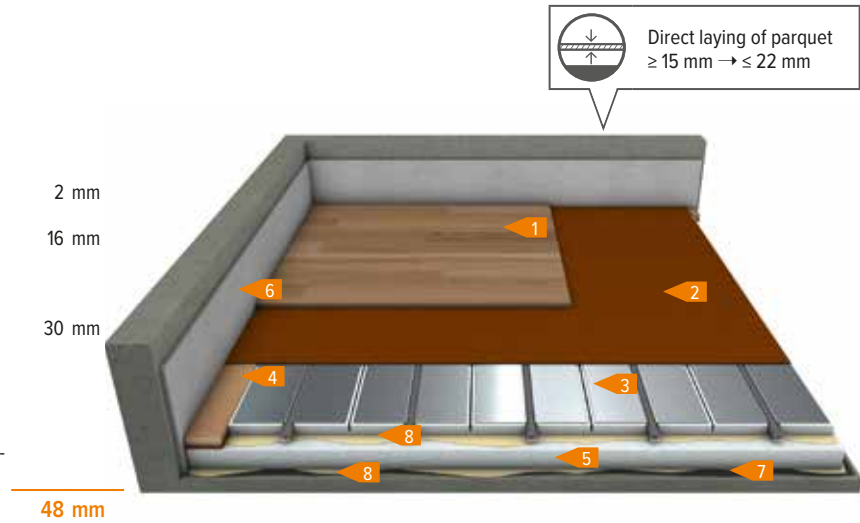

$> 1.25 \text{ m}^2\text{K/W}$	Minimum thermal resistance (Ceilings against unheated rooms/ ground) met according to DIN EN 1264	$\sim 6 \text{ kg/m}^2$ Without floor covering	Category	EN 1991	EN 1991/NA	SIA 261
		$\leq 2.0 \text{ kN/m}^2$		✓ A	✓ A2 A3	✓ A1
The carrier material EPS DEO is thermal insulation without defined impact sound insulation		$\leq 2.0 \text{ kN}$ $\geq 20 \text{ cm}^2$		–	✓ B1 D1	–
				–	–	–

1m over 3mm	Flat, smooth and load-bearing subsurface required (higher requirements in accordance with DIN 18202 tab. 3, row 4)
	Building waterproofing in accordance with DIN 18195 exists under the concrete slab in structures against the ground, otherwise must be applied on the raw floor
	Adhere system elements/material layers completely with each other and to the subsurface
	The following insulation thicknesses are permitted for a payload of $(q_k) \leq 2.0 \text{ kN/m}^2$ and an individual load $(Q_k) \leq 2.0 \text{ kN}$ : Additional insulation EPS DEO 200 kPa max. 20 mm (max. one layer) Additional insulation XPS DEO 300 kPa max. 30 mm (max. one layer) Additional insulation XPS DEO 500 kPa max. 60 mm (max. one layer)
	The specifications of the permissible individual load $(Q_k)$ relate to a load area of at least $20 \text{ cm}^2$ (compression die $\varnothing = 5 \text{ cm}$ ) If necessary, protect surface against moisture from below in accordance with manufacturer instructions (vapour barrier) Fill pipe runs max. 30 cm with bound fill. From 10 cm width, cover with a 1 mm thick plate. For pipe runs 15 cm width and larger, a separate load distribution layer (at least 18 mm) is required on the additional insulation.

Thermal output: DP  
See product data sheets and detailed information





Dry screed element (Fermacell 20 mm) without additional insulation

TECEfloor universal panel FM 16/12

- 1 Carpet / tiles / parquet / laminate / plastic
- 2 Dry screed element (Fermacell)
- 3 Adhesive (MAPEI Ecofix)
- 4 Universal panel + system pipe
- 5 Edge board (16 mm), use recommended
- 6 Edge insulation strip
- 7 Moisture barrier if applicable

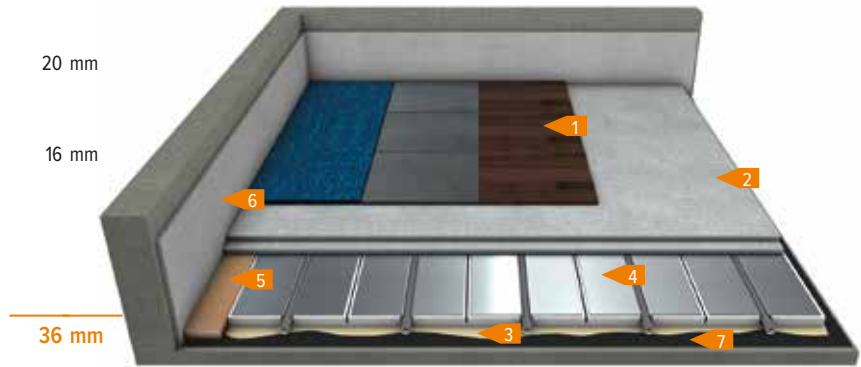

	> 0.40 m <sup>2</sup> K/W	Minimum thermal resistance in accordance with DIN EN 1264 <b>not met</b>
	~ 18 dB	Trend-setting value in accordance with DIN 4109 on solid ceilings

	~ 27 kg/m <sup>2</sup> Without floor covering
	≤ 2.0 kN/m <sup>2</sup>
	≤ 2.0 kN * ≥ 20 cm <sup>2</sup>

Category	EN 1991	EN 1991/NA	SIA 261
	✓ A	✓ A2 A3	✓ A1
	-	✓ B1 D1	-
	-	-	-

	Flat, smooth and load-bearing subsurface required (higher requirements in accordance with DIN 18202 tab. 3, row 4)
	<p>The following insulation thicknesses are permitted for a payload of (q<sub>k</sub>) ≤ 2.0 kN/m<sup>2</sup> and an individual load (Q<sub>k</sub>) ≤ 2.0 kN:</p> <ul style="list-style-type: none"> <li>Additional insulation EPS DEO 200 kPa max. 70 mm (max. one layer)</li> <li>Additional insulation XPS DEO 300 kPa max. 70 mm (max. one layer)</li> <li>Additional insulation XPS DEO 500 kPa max. 100 mm (max. one layer)</li> </ul> <p>Minimum thermal resistance in accordance with DIN EN 1264 met:</p> <ul style="list-style-type: none"> <li>· with 15 mm EPS 035 (R<sub>λ,ins</sub> = 0.82 m<sup>2</sup>K/W) for ceilings between rooms of the same temperature</li> <li>· with 30 mm EPS 035 (R<sub>λ,ins</sub> = 1.25 m<sup>2</sup>K/W) for ceilings against unheated rooms/ ground</li> </ul>
	The specifications of the permissible individual load (Q <sub>k</sub> ) relate to a load area of at least 20 cm <sup>2</sup> (compression die Ø = 5 cm) The screed thickness can be adjusted for higher payloads and individual loads

Thermal output: TE20  
See product data sheets and detailed information





Dry screed element (Fermacell 20 mm) with additional insulation

TECEfloor universal panel FM 16/12

- 1 Carpet / tiles / parquet / laminate / plastic
- 2 Dry screed element (Fermacell)
- 3 Adhesive (MAPE Ecofix)
- 4 Universal panel + system pipe
- 5 Edge board (16 mm), use recommended
- 6 Additional insulation EPS 035 DEO, 200 kPa
- 7 Edge insulation strip
- 8 Moisture barrier if applicable

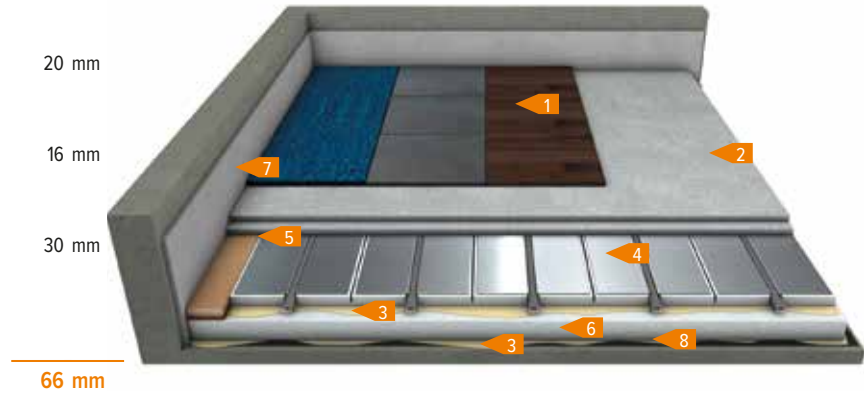

$> 1.25 \text{ m}^2\text{K/W}$	Minimum thermal resistance (Ceilings against unheated rooms/ ground) met according to DIN EN 1264	$\sim 28 \text{ kg/m}^2$ Without floor covering	Category	EN 1991	EN 1991/NA	SIA 261
$< 0.80 \text{ W/m}^2\text{K}$		$\leq 2.0 \text{ kN/m}^2$		✓ A	✓ A2 A3	✓ A1
$\sim 18 \text{ dB}$	Trend-setting value in accordance with DIN 4109 on solid ceilings	$\leq 2.0 \text{ kN}$ $\geq 20 \text{ cm}^2$		–	✓ B1 D1	–
				–	–	–

1m max. 3mm	Flat, smooth and load-bearing subsurface required (higher requirements in accordance with DIN 18202 tab. 3, row 4)
	Building waterproofing in accordance with DIN 18195 exists under the concrete slab in structures against the ground, otherwise must be applied on the raw floor
	The following insulation thicknesses are permitted for a payload of $(q_k) \leq 2.0 \text{ kN/m}^2$ and an individual load $(Q_k) \leq 2.0 \text{ kN}$ : Additional insulation EPS DEO 200 kPa max. 70 mm (max. One layer) Additional insulation XPS DEO 300 kPa max. 70 mm (max. One layer) Additional insulation XPS DEO 500 kPa max. 100 mm (max. One layer)
	The specifications of the permissible individual load $(Q_k)$ relate to a load area of at least $20 \text{ cm}^2$ (compression die $\varnothing = 5 \text{ cm}$ ) The screed thickness can be adjusted for higher payloads and individual loads

Thermal output: TE20  
See product data sheets and detailed information



Dry screed element (Fermacell 25 mm) without additional insulation

TECEfloor universal panel FM 16/12

- 1 Carpet / tiles / parquet / laminate / plastic
- 2 Dry screed element (Fermacell)
- 3 Adhesive (MAPEI Ecofix)
- 4 Universal panel + system pipe
- 5 Edge board (16 mm), use recommended
- 6 Edge insulation strip
- 7 Moisture barrier if applicable

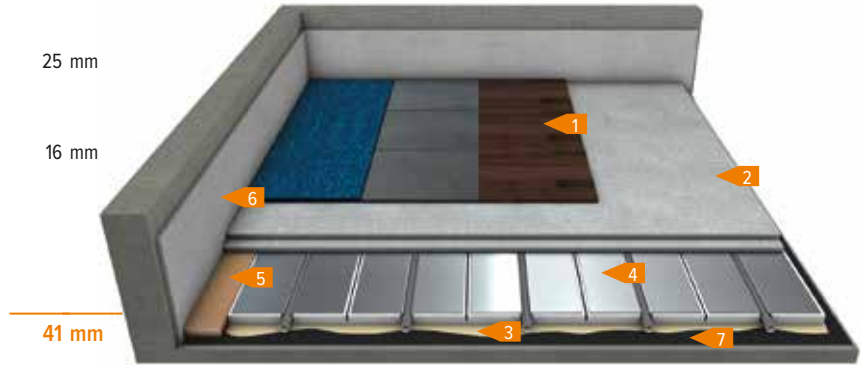

	> 0.40 m <sup>2</sup> K/W	Minimum thermal resistance in accordance with DIN EN 1264 <b>not met</b>
	~ 18 dB	Trend-setting value in accordance with DIN 4109 on solid ceilings

	~ 33 kg/m <sup>2</sup> Without floor covering
	≤ 4.0 kN/m <sup>2</sup>
	≤ 3.0 kN * ≥ 20 cm <sup>2</sup>

Category	EN 1991	EN 1991/NA	SIA 261
	✓ A	✓ A2 A3	✓ A1
	-	✓ B1 D1	-
	-	✓ B2 C1	✓ B

	Flat, smooth and load-bearing subsurface required (higher requirements in accordance with DIN 18202 tab. 3, row 4)
	<p>The following insulation thicknesses are permitted for a payload of (q<sub>k</sub>) ≤ 4.0 kN/m<sup>2</sup> and an individual load (Q<sub>k</sub>) ≤ 3.0 kN:</p> <ul style="list-style-type: none"> <li>Additional insulation EPS DEO 200 kPa max. 70 mm (max. one layer)</li> <li>Additional insulation XPS DEO 300 kPa max. 70 mm (max. one layer)</li> <li>Additional insulation XPS DEO 500 kPa max. 90 mm (max. one layer)</li> </ul> <p>Minimum thermal resistance in accordance with DIN EN 1264 met:</p> <ul style="list-style-type: none"> <li>· with 15 mm EPS 035 (R<sub>λ,ins</sub> = 0.82 m<sup>2</sup>K/W) for ceilings between rooms of the same temperature</li> <li>· with 30 mm EPS 035 (R<sub>λ,ins</sub> = 1.25 m<sup>2</sup>K/W) for ceilings against unheated rooms/ ground</li> </ul>
	<p>The specifications of the permissible individual load (Q<sub>k</sub>) relate to a load area of at least 20 cm<sup>2</sup> (compression die Ø = 5 cm)</p> <p>The screed thickness can be adjusted for higher payloads and individual loads</p>

Thermal output: TE25  
See product data sheets and detailed information



Dry screed element (Fermacell 25 mm) with additional insulation

TECEfloor universal panel FM 16/12

- 1 Carpet / tiles / parquet / laminate / plastic
- 2 Dry screed element (Fermacell)
- 3 Adhesive (MAPE Ecofix)
- 4 Universal panel + system pipe
- 5 Edge board (16 mm), use recommended
- 6 Additional insulation EPS 035 DEO, 200 kPa
- 7 Edge insulation strip
- 8 Moisture barrier if applicable

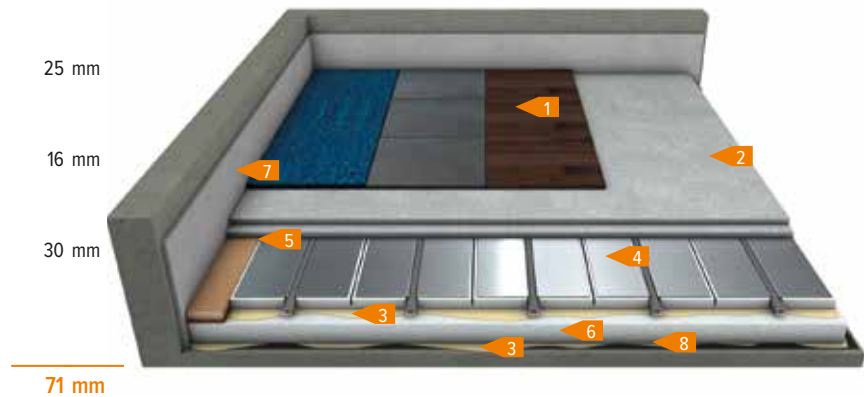

$> 1.25 \text{ m}^2\text{K/W}$	Minimum thermal resistance (Ceilings against unheated rooms/ ground) met according to DIN EN 1264	$\sim 34 \text{ kg/m}^2$ Without floor covering	Category	EN 1991	EN 1991/NA	SIA 261
		$\leq 4.0 \text{ kN/m}^2$		✓ A	✓ A2 A3	✓ A1
$\sim 18 \text{ dB}$	Trend-setting value in accordance with DIN 4109 on solid ceilings	$\leq 3.0 \text{ kN}$ $\geq 20 \text{ cm}^2$		-	✓ B1 D1	-
				-	✓ B2 C1	-

1m max. 3mm	Flat, smooth and load-bearing subsurface required (higher requirements in accordance with DIN 18202 tab. 3, row 4)
	Building waterproofing in accordance with DIN 18195 exists under the concrete slab in structures against the ground, otherwise must be applied on the raw floor
	The following insulation thicknesses are permitted for a payload of $(q_k) \leq 4.0 \text{ kN/m}^2$ and an individual load $(Q_k) \leq 3.0 \text{ kN}$ : Additional insulation EPS DEO 200 kPa max. 70 mm (max. one layer) Additional insulation XPS DEO 300 kPa max. 70 mm (max. one layer) Additional insulation XPS DEO 500 kPa max. 90 mm (max. one layer)
	The specifications of the permissible individual load $(Q_k)$ relate to a load area of at least $20 \text{ cm}^2$ (compression die $\varnothing = 5 \text{ cm}$ ) The screed thickness can be adjusted for higher payloads and individual loads

Thermal output: TE25  
See product data sheets and detailed information



## Insulation mat UP | Tiles | Laminate

Quick design table TECEfloor universal panel UP 16/12

Insulation mat: Tile > 10 mm, Natural stone > 15 mm, Laminate > 8 mm

Mean heating water temperature				30 °C			35 °C		
Thermal resistance	Room temperature	Spacing	Heating pipe requirement	Max. heat flux density	Mean surface temperature	Max. heating circuit area	Max. heat flux density	Mean surface temperature	Max. heating circuit area
RI,B	ti	VA	L	q	to	Dim. 12	q	to	Dim. 12
m <sup>2</sup> K/W	°C	(cm)	(m)	(W/m <sup>2</sup> )	(°C)	(m <sup>2</sup> )	(W/m <sup>2</sup> )	(°C)	(m <sup>2</sup> )
0.01	20 °C	15	6.6	55	25.1	13.2	82	27.6	10.4
	24 °C	15	6.6	33	27.1	18.5	61	29.6	13.1
0.05	20 °C	15	6.6	44	24.1	15.3	65	26.0	12.0
0.10	20 °C	15	6.6	35	23.2	17.7	52	24.8	14.1
0.15	20 °C	15	6.6	29	22.7	20.1	43	24.0	15.8

Mean heating water temperature				40 °C			45 °C		
Thermal resistance	Room temperature	Spacing	Heating pipe requirement	Max. heat flux density	Mean surface temperature	Max. heating circuit area	Max. heat flux density	Mean surface temperature	Max. heating circuit area
RI,B	ti	VA	L	q	to	Dim. 12	q	to	Dim. 12
m <sup>2</sup> K/W	°C	(cm)	(m)	(W/m <sup>2</sup> )	(°C)	(m <sup>2</sup> )	(W/m <sup>2</sup> )	(°C)	(m <sup>2</sup> )
0.01	20 °C	15	6.6	110	30.2	8.4	137	32.7	7.2
	24 °C	15	6.6	88	32.1	9.8	115	34.6	8.1
0.05	20 °C	15	6.6	87	28.1	9.8	109	30.1	8.4
0.10	20 °C	15	6.6	70	26.5	11.4	87	28.1	9.8
0.15	20 °C	15	6.6	58	25.4	12.9	72	26.7	11.1

Max. heating circuit area (plus 2 x 5 m connection line) applicable for DT = 10 K (tV-tR) and Dp = 200 mbar (including distributor).

Max. surface temperatures according to DIN EN 1264

Living zones: 29 °C/edge zones (max. 1 m): 35 °C | Bathrooms: 33 °C



Construction: DA 01, DA 02, DA 04, DA 05  
See product data sheets and detailed information

## Insulation mat UP | Tiles | Laminate

Heat output diagram TECEfloor universal panel UP 16/12

Insulation mat: Tile > 10 mm, Natural stone > 15 mm, Laminate > 8 mm

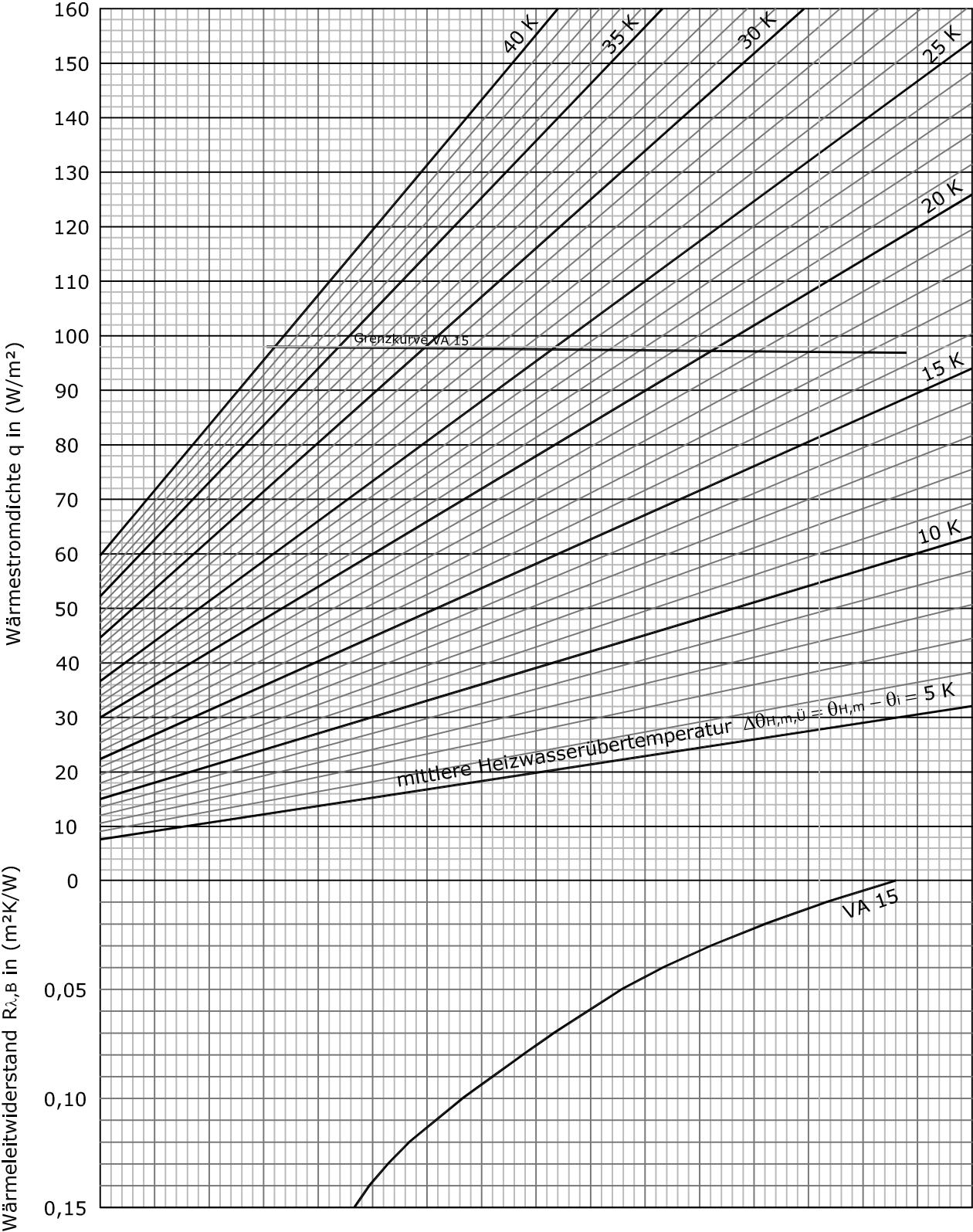



## Direct laying of parquet | Solid floorboards on floor battens

Quick design table TECEfloor universal panel UP 16/12  
 Direct laying of parquet > 15 mm with impact sound strip

Mean heating water temperature				30 °C			35 °C		
Thermal resistance	Room temperature	Spacing	Heating pipe requirement	Max. heat flux density	Mean surface temperature	Max. heating circuit area	Max. heat flux density	Mean surface temperature	Max. heating circuit area
RI,B	ti	VA	L	q	to	Dim. 12	q	to	Dim. 12
m <sup>2</sup> K/W	°C	(cm)	(m)	(W/m <sup>2</sup> )	(°C)	(m <sup>2</sup> )	(W/m <sup>2</sup> )	(°C)	(m <sup>2</sup> )
0.10	20 °C	15	6.6	37	23.4	17.1	55	25.1	13.5
0.15	20 °C	15	6.6	30	22.8	19.7	45	24.2	15.5

Mean heating water temperature				40 °C			45 °C		
Thermal resistance	Room temperature	Spacing	Heating pipe requirement	Max. heat flux density	Mean surface temperature	Max. heating circuit area	Max. heat flux density	Mean surface temperature	Max. heating circuit area
RI,B	ti	VA	L	q	to	Dim. 12	q	to	Dim. 12
m <sup>2</sup> K/W	°C	(cm)	(m)	(W/m <sup>2</sup> )	(°C)	(m <sup>2</sup> )	(W/m <sup>2</sup> )	(°C)	(m <sup>2</sup> )
0.10	20 °C	15	6.6	73	26.8	10.1	92	28.5	9.3
0.15	20 °C	15	6.6	60	25.6	12.8	75	26.9	10.9

Max. heating circuit area (plus 2 x 5 m connection line) applicable for DT = 10 K (tV-tR) and Dp = 200 mbar (including distributor).  
 Max. surface temperatures according to DIN EN 1264  
 Living zones: 29 °C/edge zones (max. 1 m): 35 °C | Bathrooms: 33 °C

## Direct laying of parquet | Solid floorboards on floor battens

Heat output diagram TECEfloor universal panel UP 16/12  
 Direct laying of parquet > 15 mm with impact sound strip

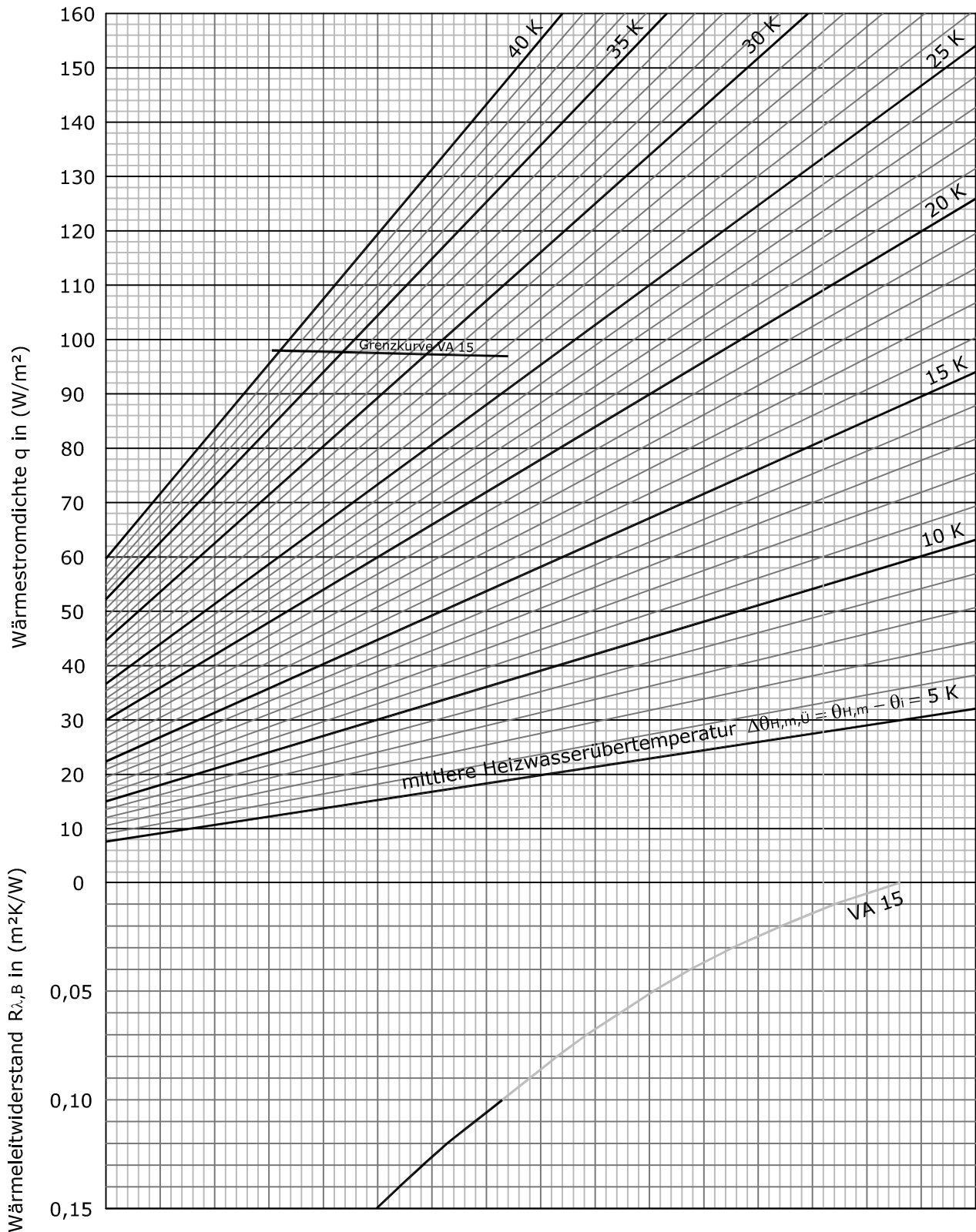

Construction: DP 01, DP 02  
 See product data sheets and detailed information



## Dry screed element (Fermacell 20 mm)

Quick design table TECEfloor universal panel UP 16/12

Load distribution layer: Dry screed element  $s_{\ddot{u}} = 20 \text{ mm}$ , with  $\lambda_{\ddot{u}} = 0.28 \text{ W/mK}$

Mean heating water temperature				30 °C			35 °C		
Thermal resistance	Room temperature	Spacing	Heating pipe requirement	Max. heat flux density	Mean surface temperature	Max. heating circuit area	Max. heat flux density	Mean surface temperature	Max. heating circuit area
RI,B	$t_i$	VA	L	q	$t_o$	Dim. 12	q	$t_o$	Dim. 12
$\text{m}^2\text{K/W}$	°C	(cm)	(m)	( $\text{W}/\text{m}^2$ )	(°C)	( $\text{m}^2$ )	( $\text{W}/\text{m}^2$ )	(°C)	( $\text{m}^2$ )
0.01	20 °C	15	6.6	41	23.8	16.1	61	25.6	12.6
	24 °C	15	6.6	24	26.2	22.8	45	28.2	15.8
0.05	20 °C	15	6.6	34	23.1	18.2	51	24.7	14.3
0.10	20 °C	15	6.6	28	22.6	20.6	42	23.9	15.8
0.15	20 °C	15	6.6	24	22.2	22.8	36	23.3	17.7

Mean heating water temperature				40 °C			45 °C		
Thermal resistance	Room temperature	Spacing	Heating pipe requirement	Max. heat flux density	Mean surface temperature	Max. heating circuit area	Max. heat flux density	Mean surface temperature	Max. heating circuit area
RI,B	$t_i$	VA	L	q	$t_o$	Dim. 12	q	$t_o$	Dim. 12
$\text{m}^2\text{K/W}$	°C	(cm)	(m)	( $\text{W}/\text{m}^2$ )	(°C)	( $\text{m}^2$ )	( $\text{W}/\text{m}^2$ )	(°C)	( $\text{m}^2$ )
0.01	20 °C	15	6.6	81	27.5	10.4	101	29.4	8.9
	24 °C	15	6.6	65	30.0	12.0	85	31.9	9.9
0.05	20 °C	15	6.6	68	26.3	11.6	85	27.9	9.9
0.10	20 °C	15	6.6	57	25.3	13.1	71	26.6	11.3
0.15	20 °C	15	6.6	49	24.5	14.4	61	25.6	12.5

Max. heating circuit area (plus 2 x 5 m connection line) applicable for  $\Delta T = 10 \text{ K}$  ( $t_V - t_R$ ) and  $D_p = 200 \text{ mbar}$  (including distributor).

Max. surface temperatures according to DIN EN 1264

Living zones: 29 °C/edge zones (max. 1 m): 35 °C | Bathrooms: 33 °C



Construction: TE20 01, TE20 02  
See product data sheets and detailed information



## Dry screed element (Fermacell 20 mm)

Heat output diagram TECEfloor universal panel UP 16/12

Load distribution layer: Dry screed element  $s_{\ddot{u}} = 20$  mm, with  $\lambda_{\ddot{u}} = 0.28$  W/mK

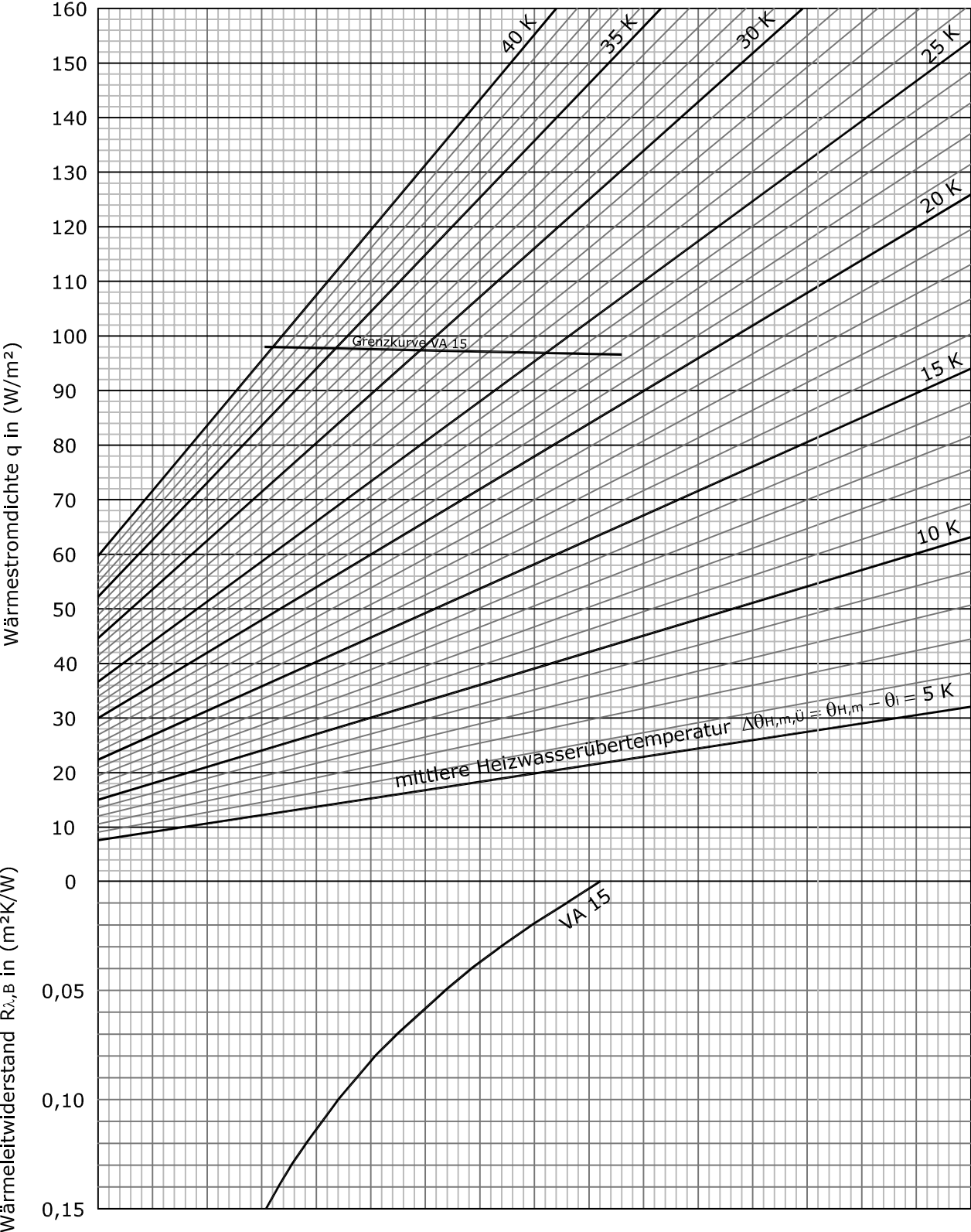



## Dry screed element (Fermacell 25 mm)

Quick design table TECEfloor universal panel UP 16/12

Load distribution layer: Dry screed element  $s_{\ddot{u}} = 25 \text{ mm}$ , with  $\lambda_{\ddot{u}} = 0.28 \text{ W/mK}$

Mean heating water temperature				30 °C			35 °C		
Thermal resistance	Room temperature	Spacing	Heating pipe requirement	Max. heat flux density	Mean surface temperature	Max. heating circuit area	Max. heat flux density	Mean surface temperature	Max. heating circuit area
RI,B	$t_i$	VA	L	q	$t_o$	Dim. 12	q	$t_o$	Dim. 12
$\text{m}^2\text{K/W}$	°C	(cm)	(m)	( $\text{W}/\text{m}^2$ )	(°C)	( $\text{m}^2$ )	( $\text{W}/\text{m}^2$ )	(°C)	( $\text{m}^2$ )
0.01	20 °C	15	6.6	37	23.4	17.1	55	25.1	13.5
	24 °C	15	6.6	22	26.0	24.2	41	27.8	16.8
0.05	20 °C	15	6.6	31	22.9	19.2	47	24.4	14.9
0.10	20 °C	15	6.6	27	22.5	21.2	40	23.7	16.8
0.15	20 °C	15	6.6	24	22.2	23.4	35	23.2	18.5

Mean heating water temperature				40 °C			45 °C		
Thermal resistance	Room temperature	Spacing	Heating pipe requirement	Max. heat flux density	Mean surface temperature	Max. heating circuit area	Max. heat flux density	Mean surface temperature	Max. heating circuit area
RI,B	$t_i$	VA	L	q	$t_o$	Dim. 12	q	$t_o$	Dim. 12
$\text{m}^2\text{K/W}$	°C	(cm)	(m)	( $\text{W}/\text{m}^2$ )	(°C)	( $\text{m}^2$ )	( $\text{W}/\text{m}^2$ )	(°C)	( $\text{m}^2$ )
0.01	20 °C	15	6.6	74	26.9	11.0	90	28.3	9.5
	24 °C	15	6.6	59	25.5	12.9	77	27.1	10.7
0.05	20 °C	15	6.6	63	29.5	12.2	77	31.1	10.4
0.10	20 °C	15	6.6	54	25.0	13.7	66	26.1	11.7
0.15	20 °C	15	6.6	46	24.3	15.0	58	25.4	12.9

Max. heating circuit area (plus 2 x 5 m connection line) applicable for  $\Delta T = 10 \text{ K}$  ( $t_V - t_R$ ) and  $D_p = 200 \text{ mbar}$  (including distributor).

Max. surface temperatures according to DIN EN 1264

Living zones: 29 °C/edge zones (max. 1 m): 35 °C | Bathrooms: 33 °C



Construction: TE25 01, TE25 02  
See product data sheets and detailed information

## Dry screed element (Fermacell 25 mm)

Heat output diagram TECEfloor universal panel UP 16/12

Load distribution layer: Dry screed element  $s_{\ddot{u}} = 25 \text{ mm}$ , with  $\lambda_{\ddot{u}} = 0.28 \text{ W/mK}$

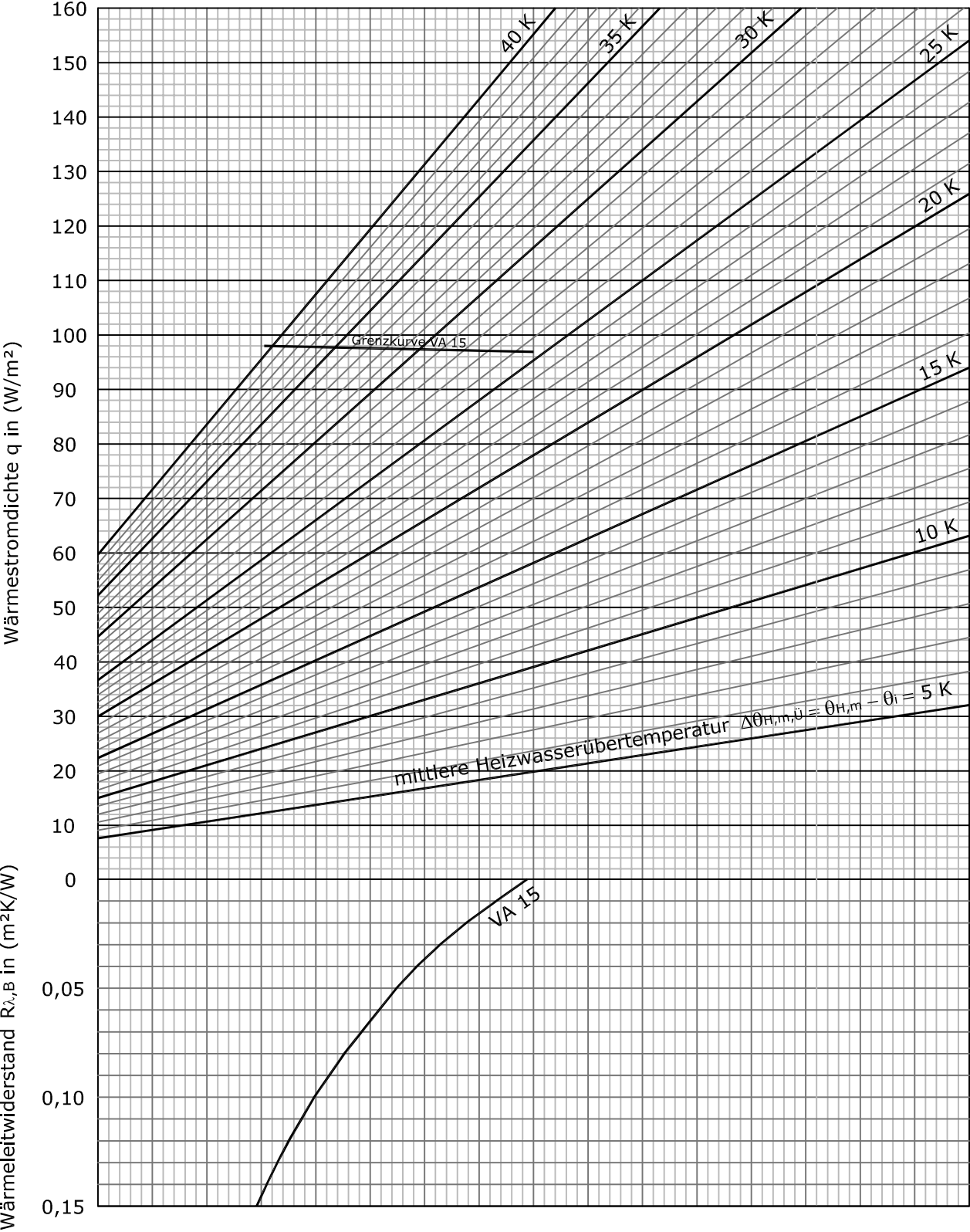

## Installation instructions for universal panel UP 16/12

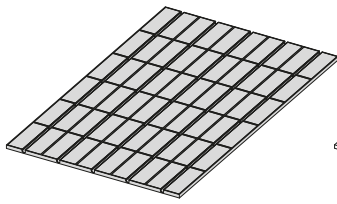

77520001

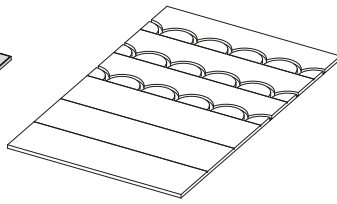

77520002

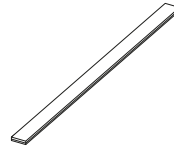

77520003



(77520020)

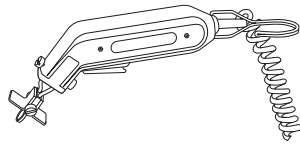

(77520021)



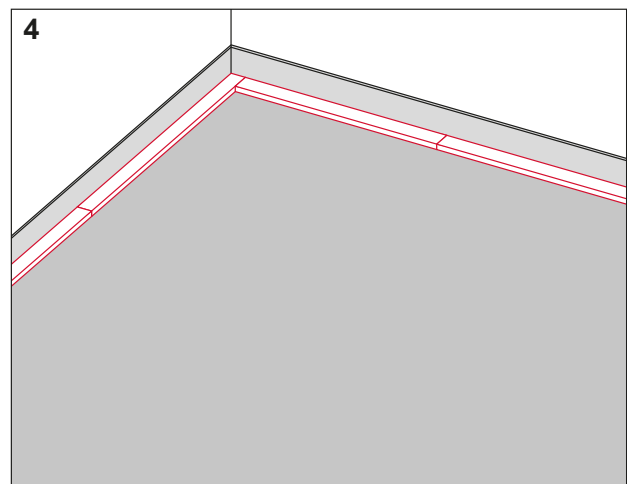
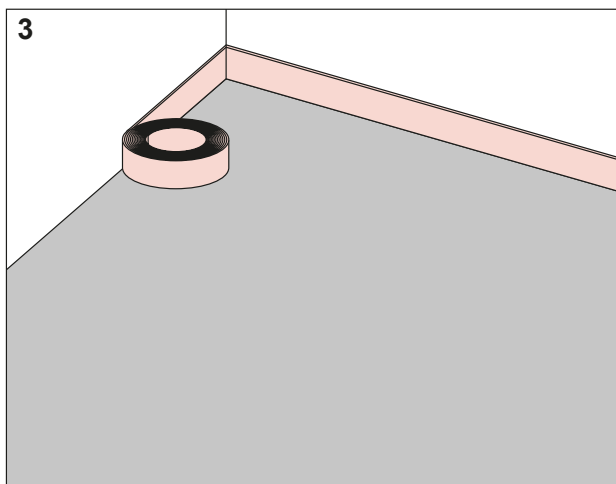
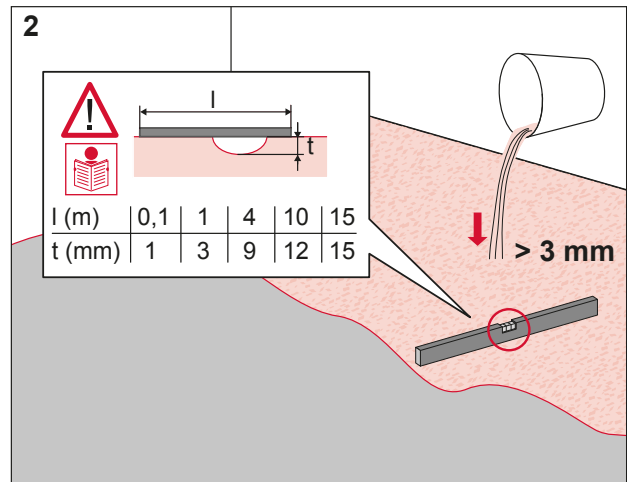
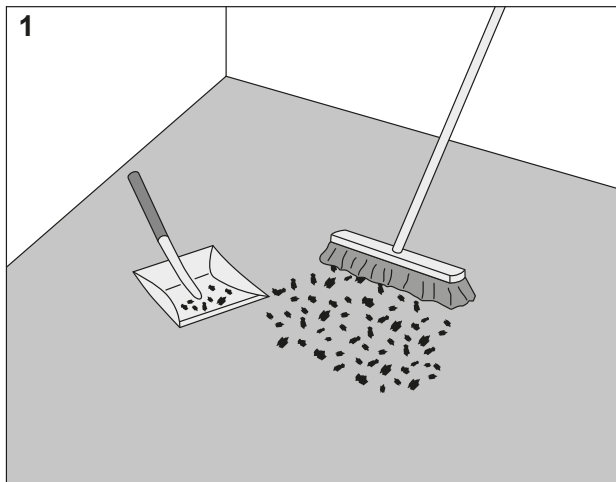

TECEfloor Technische Informationen lesen!  
Read TECEfloor Technical Information!



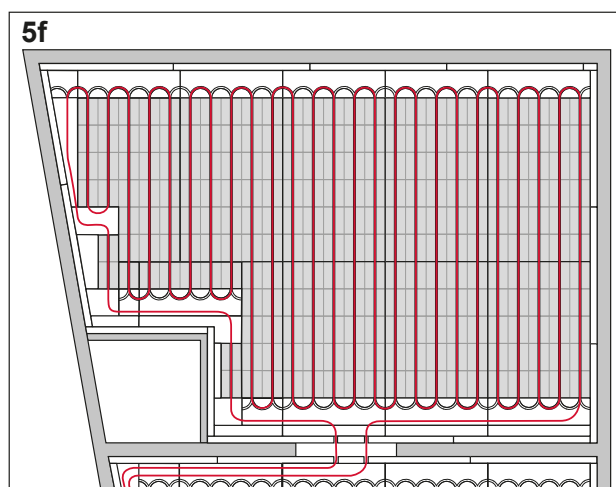
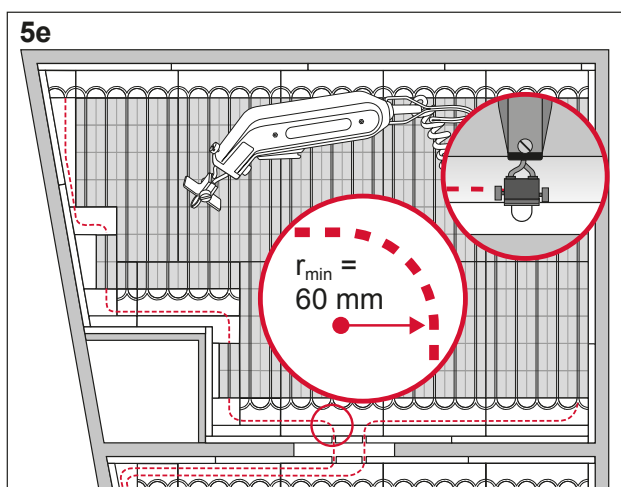
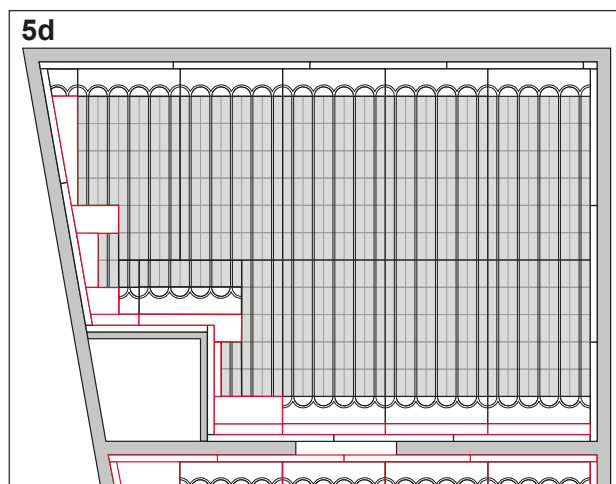
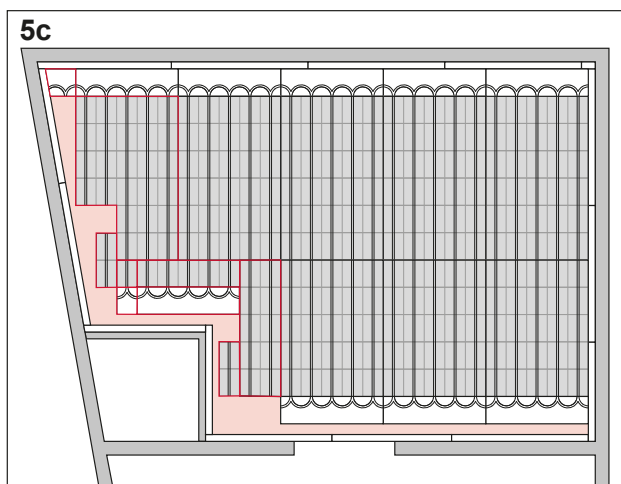
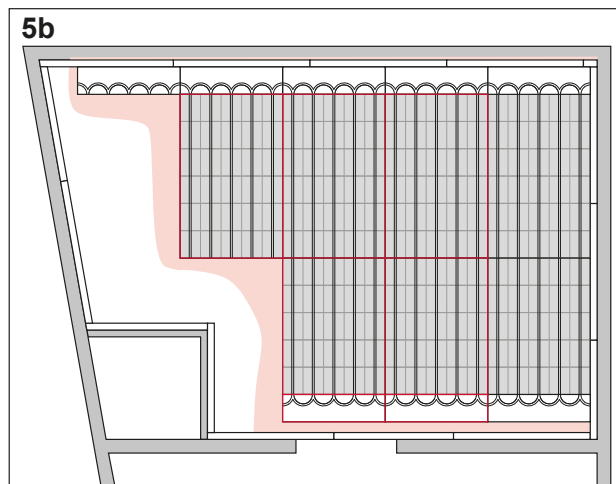
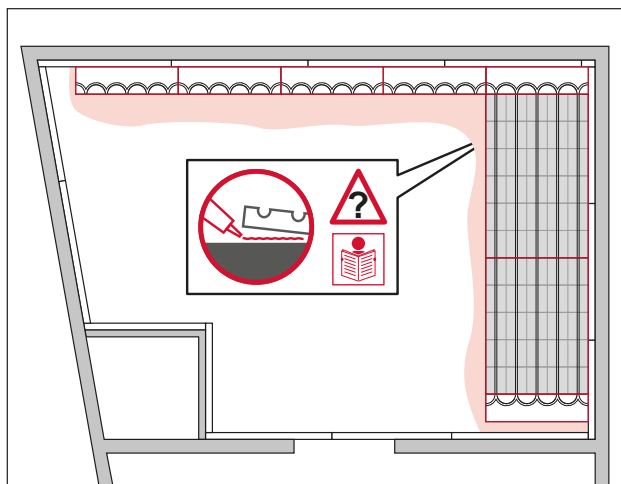

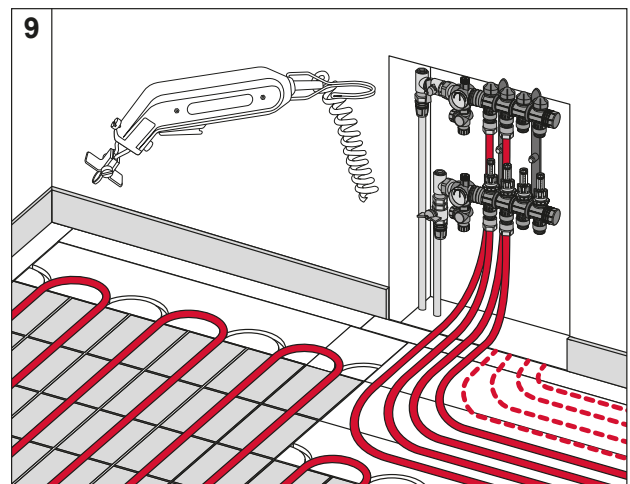
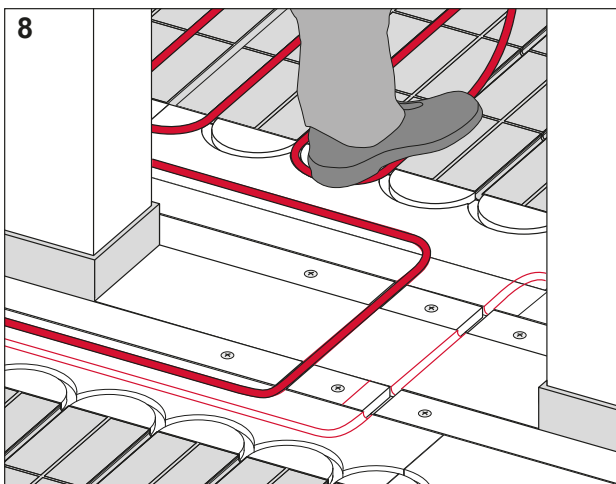
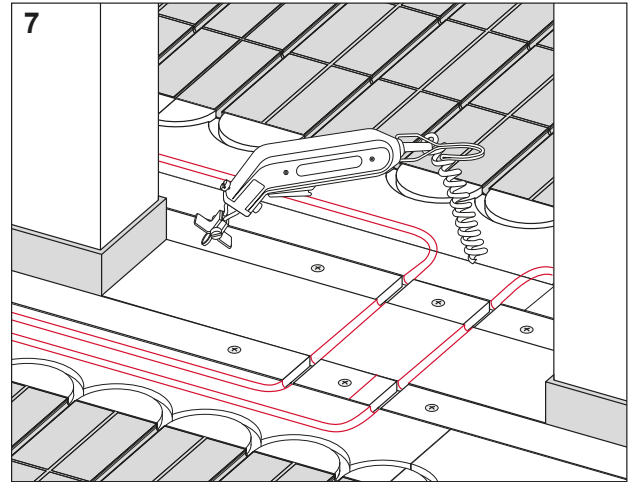
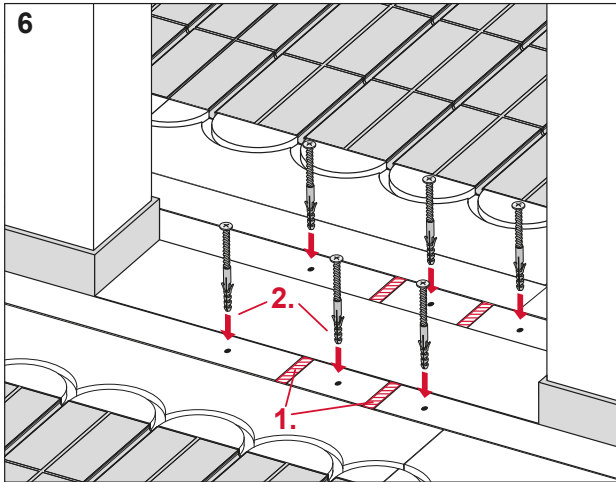

# Installation instructions for universal panel UP 16/12



## Installation instructions for universal panel UP 16/12

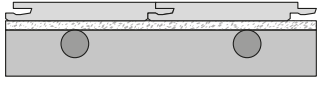

Weitere Fußbodenaufbauten entnehmen Sie bitte den Technischen Informationen TECEfloor.

Further floor constructions please see Technical Information TECEfloor.

• • •

## Installation information for Ultrabond Eco Fix UP

Ultrabond Eco Fix is a very low-emission universal dispersion bonding for textile and CV coverings. It is used to bond the TECEfloor universal panel UP to the subsurface and to bond the TECEfloor insulation mat UP with the universal panel. Ultrabond Eco Fix is suitable for all standard subsurfaces used in the construction industry.

The following information is only an extract from the original installation information from the company Mapei. Read and observe this information completely before installation.

### Important information:

- The best handling conditions are at +15 °C to +35 °C and a relative humidity of < 75 %. Lower temperatures and high humidity extend the ventilation and installation time, while high temperatures and low humidity shorten the ventilation and installation time.
- Do not insert the covering or universal panel and the insulation mat in freshly applied bonding. During installation, a nearly solid installation is achieved within about 10-20 minutes.

### Subsurface preparation:

- The subsurface must meet the requirements of the respective standard with respect to the installation readiness.
- The subsurface must be uniformly dry, free of cracks, absorbent, flat, pressure and tensile-resistant and may not have any separating substances that may impair adhesion.
- Prime absorbent and porous subsurfaces beforehand with primer G, Eco Prim R, Primer MF or Mapeprim SP.
- Ultrabond Eco Fix can generally be directly applied to smooth even surfaces.

### Installation:

- Ultrabond Eco Fix is ready to use. The listed bonding is applied to the subsurface evenly in a thin layer with a fine-toothed putty knife or a paint roller. Application with a paint roller has proven advantageous, since it ensures a uniform application amount, regardless of the putty knife geometry.
- After complying with the required ventilation time, the covering is placed and rubbed smooth all over. If you would like to have the subsurface free of the bonding, Ultrabond Fix must be applied to the back side of the covering.

### Consumption:

- Depending on the subsurface, the back side of the covering, the application area and the installation tool, consumption varies between 80-200 g/m<sup>2</sup> per bonding.

### Storage:

- Ultrabond ECO Fix can be stored for 24 months in the unopened original container. Protect from freezing.



# The new TECEfloor dry-wall construction system 30/16

With just two components:



TECEfloor dry-wall panel TP 30/16



TECEfloor heat-conduction profile TP 30/16 in aluminium or steel

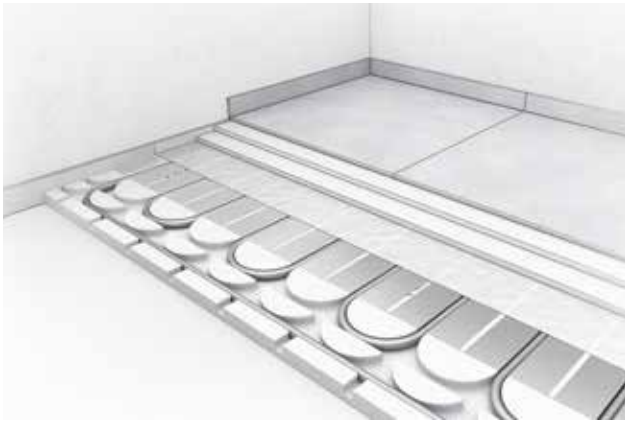

Standard dry-wall design: e.g. with 25 mm dry screed.  
Installation height 55 mm incl. lay surface.

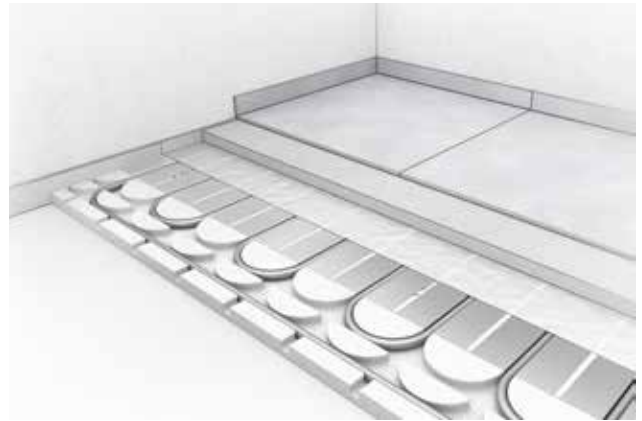

Alternative construction: e.g. with cement screed and  
TECEfloor screed additive "Special".  
Installation height 60 mm incl. lay surface.

## Easy installation, short construction period

The TECEfloor dry-wall construction system 30/16 is the standard dry-wall construction system in combination with dry screed elements (e.g. Fermacell, Knauf). For a particularly light floor construction with short construction times and zero drying times. A lower construction height or a lower area weight with faster heating times is also possible in combination with thin-bed screeds.

### Product features

- Only two individual components and optimised panel dimensions – simple handling and processing, reduced storage
- Single and double meander laying - equal surface temperatures and even heat release
- Minimum thermal resistance  $\geq 0.75 \text{ m}^2\text{K/W}$  to DIN 1264 – conforms to standards
- Heat conduction profile with integrated pre-determined breaking points, in a choice of steel or aluminium – separable without tools





## TECEfloor dry-wall panel TP 30/16

### Product data

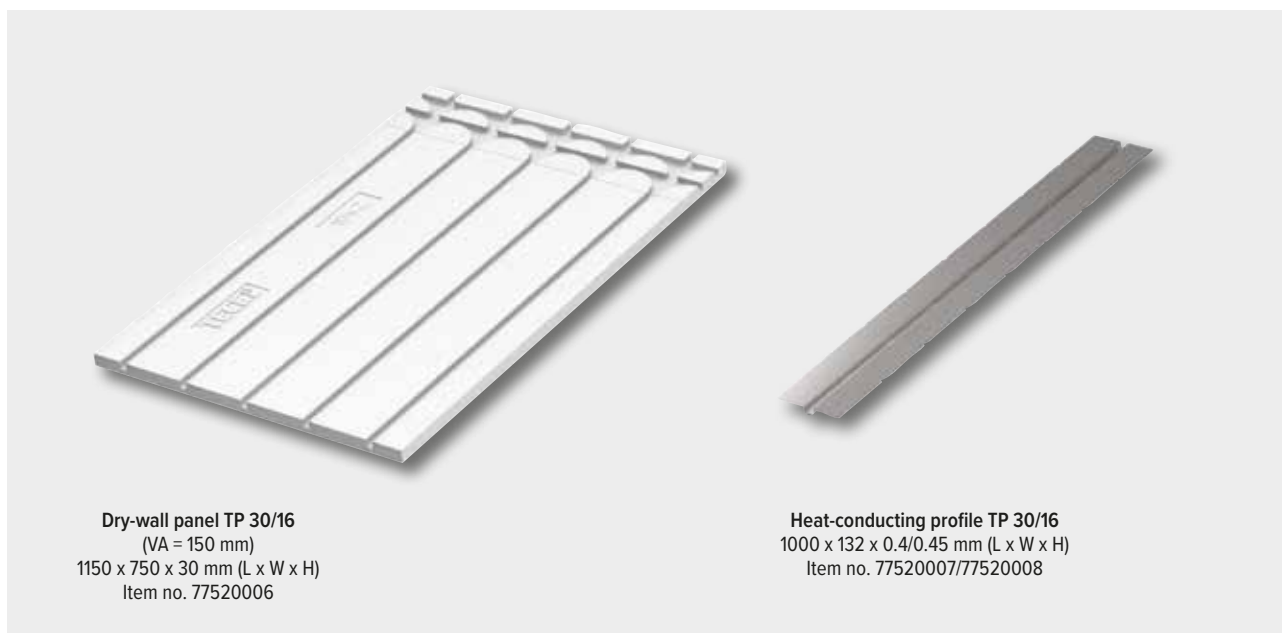

<b>Material</b>	Base plate	Polystyrene plate EPS 035 DE0; 150 kPa
	Heat conducting plate	Aluminium 0.45 mm, galvanised steel, 0.4 mm
<b>Data</b>	Thermal conductivity	0.035 W/mK
	Thermal resistance	> 0.80 m <sup>2</sup> K/W
	Compression strength	150 kPa at 10 % compression in accordance with DIN EN 826
	Fire behaviour	Euroclass E as per DIN EN 13501-1
	Tube diameter	ø 16 mm

Prerequisite in accordance with DIN 18202		Inside micrometers as limit values in mm for measuring point intervals in m				
		0.1 m	1 m	4 m	10 m	15 m
Line	Reference					
4	Ready-to-cover floors with higher requirements, e.g. with self-levelling fillers	1 mm	3 mm	9 mm	12 mm	15 mm



Dry screed element (Fermacell 25 mm)

TECEfloor dry-wall panel TP 30/16

- 1 Carpet / tiles / parquet / laminate / plastic
- 2 Dry screed element (Fermacell) 25 mm
- 3 Dry-wall panel TP 30/16 + system pipe 30 mm
- 4 Additional insulation EPS 035 DEO, 200 kPa (optional)
- 5 Edge insulation strip
- 6 Moisture barrier if applicable

55 mm

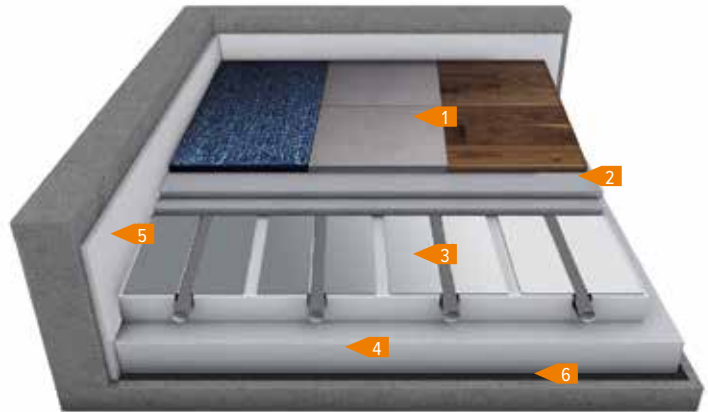

	> 0.80 m <sup>2</sup> K/W	Minimum thermal resistance (ceilings between rooms of the same temperature) met according to DIN EN 1264
	~ 18 dB	Trend-setting value in accordance with DIN 4109 on solid ceilings

	~ 34 kg/m <sup>2</sup> Without floor covering
	≤ 2.0 kN/m <sup>2</sup>
	≤ 2.0 kN * ≥ 20 cm <sup>2</sup>

Category	EN 1991	EN 1991/NA	SIA 261
	✓ A	✓ A2 A3	✓ A1
	-	✓ B1 D1	-
	-	-	-

	Flat, smooth and load-bearing subsurface required (higher requirements in accordance with DIN 18202 tab. 3, row 4)
	<p>The following insulation thicknesses are permitted for a payload of (qk) ≤ 2.0 kN/m<sup>2</sup> and an individual load (Qk) ≤ 2.0 kN:</p> <ul style="list-style-type: none"> <li>Additional insulation EPS DEO 200 kPa max. 70 mm (max. one layer)</li> <li>Additional insulation XPS DEO 300 kPa max. 70 mm (max. one layer)</li> <li>Additional insulation XPS DEO 500 kPa max. 90 mm (max. one layer)</li> </ul> <p>Minimum thermal resistance in accordance with DIN EN 1264 met:</p> <ul style="list-style-type: none"> <li>· with 20 mm EPS 035 (R<sub>λ,ins</sub> = 1.37 m<sup>2</sup>K/W) for ceilings against unheated rooms/ ground</li> </ul>
	<p>The specifications of the permissible individual load (Q<sub>k</sub>) relate to a load area of at least 20 cm<sup>2</sup> (compression die Ø = 5 cm)</p> <p>The screed thickness can be adjusted for higher payloads and individual loads</p>

	<p>Thermal output: TE25 TP</p> <p>See product data sheets and detailed information</p>
--	--



Cement screed CT-F5 + TECEfloor screed additive Special

TECEfloor dry-wall panel TP 30/16

- 1 Carpet / tiles / parquet / laminate / plastic
- 2 Cement screed CT-F5 + screed additive Special ≥ 30 mm
- 3 Separating layer
- 4 Dry-wall panel TP 30/16 + system pipe 30 mm
- 5 Additional insulation EPS 035 DEO, 200 kPa (optional)
- 6 Edge insulation strip
- 7 Moisture barrier if applicable ≥ 60 mm



	> 0.8 m <sup>2</sup> K/W	Minimum thermal resistance (ceilings between rooms of the same temperature) met according to DIN EN 1264
	≥ 24 dB	Calculated value in accordance with DIN 4109 on solid ceilings

	65 kg/m <sup>2</sup>
	≤ 2.0 kN/m <sup>2</sup>
	≤ 2.0 kN

Category	EN 1991	EN 1991/NA	SIA 261
	✓ A	✓ A2 A3	✓ A1
	–	✓ B1 D1	✓ B
	–	–	–

	Flat, smooth and load-bearing subsurface required (higher requirements in accordance with DIN 18202 tab. 3, row 4)
	<p>The following insulation thicknesses are permitted for a payload of (qk) ≤ 2.0 kN/m<sup>2</sup> and an individual load (Qk) ≤ 2.0 kN:</p> <p>Additional insulation EPS DEO 200 kPa max. 70 mm (max. one layer)</p> <p>Additional insulation XPS DEO 300 kPa max. 70 mm (max. one layer)</p> <p>Additional insulation XPS DEO 500 kPa max. 90 mm (max. one layer)</p> <p>Minimum thermal resistance in accordance with DIN EN 1264 met:</p> <ul style="list-style-type: none"> <li>with 20 mm EPS 035 (R<sub>λ,ins</sub> = 1.37 m<sup>2</sup>K/W) for ceilings against unheated rooms/ ground</li> </ul>
	<p>The specifications of the permissible individual load (Qk) relate to a load area of at least 20 cm<sup>2</sup> (compression die Ø = 5 cm)</p> <p>The screed thickness can be adjusted for higher payloads and individual loads</p>

Thermal output: CT30 TP  
See product data sheets and detailed information



## Dry screed element (Fermacell 25 mm) with aluminium profiles

Quick design table TECEfloor dry-wall construction system TP 30/16 (with aluminium profiles)

Load distribution layer: Dry screed element  $s_{\ddot{u}} = 25$  mm, with  $\lambda_{\ddot{u}} = 0.28$  W/mK

Mean heating water temperature				30 °C			35 °C		
Thermal resistance	Room temperature	Spacing	Heating pipe requirement	Max. heat flux density	Mean surface temperature	Max. heating circuit area	Max. heat flux density	Mean surface temperature	Max. heating circuit area
RI,B	$t_i$	VA	L	q	$t_o$	Dim. 16	q	$t_o$	Dim. 16
$m^2K/W$	°C	(cm)	(m)	( $W/m^2$ )	(°C)	( $m^2$ )	( $W/m^2$ )	(°C)	( $m^2$ )
0.01	20 °C	15	6.6	40	23.7	26.7	60	25.6	20.4
		30	3.3	25	22.3	46.2	38	23.5	34.8
	24 °C	15	6.6	24	26.2	37.5	44	28.1	25.1
		30	3.3	15	25.4	64.5	28	26.6	42.9
0.05	20 °C	15	6.6	34	23.1	29.9	50	24.6	22.8
		30	3.3	22	22.0	50.1	33	23.1	38.4
0.10	20 °C	15	6.6	28	22.6	33.8	42	23.9	25.8
		30	3.3	19	21.8	55.5	28	22.6	42.9
0.15	20 °C	15	6.6	24	22.2	37.5	36	23.3	28.8
		30	3.3	17	21.6	59.7	25	22.3	46.2

Mean heating water temperature				40 °C			45 °C		
Thermal resistance	Room temperature	Spacing	Heating pipe requirement	Max. heat flux density	Mean surface temperature	Max. heating circuit area	Max. heat flux density	Mean surface temperature	Max. heating circuit area
RI,B	$t_i$	VA	L	q	$t_o$	Dim. 16	q	$t_o$	Dim. 16
$m^2K/W$	°C	(cm)	(m)	( $W/m^2$ )	(°C)	( $m^2$ )	( $W/m^2$ )	(°C)	( $m^2$ )
0.01	20 °C	15	6.6	80	27.4	16.8	98	29.1	14.7
		30	3.3	50	24.6	28.8	61	25.6	24.9
	24 °C	15	6.6	64	29.9	19.5	84	31.8	16.2
		30	3.3	40	27.7	33.6	52	28.8	27.9
0.05	20 °C	15	6.6	68	26.3	18.8	83	27.7	16.5
		30	3.3	44	24.1	31.5	53	24.9	27.3
0.10	20 °C	15	6.6	56	25.2	21.2	69	26.4	18.6
		30	3.3	38	23.5	34.8	46	24.3	30.6
0.15	20 °C	15	6.6	48	24.4	23.7	59	25.5	20.7
		30	3.3	34	23.1	37.5	42	23.9	32.7

Max. heating circuit area (plus 2 x 5 m connection line) applicable for  $DT = 10$  K ( $t_V - t_R$ ) and  $D_p = 200$  mbar (including distributor).

Max. surface temperatures according to DIN EN 1264

Living zones: 29°C/edge zones (max. 1 m): 35°C | Bathrooms: 33 °C



Construction: TE25 TP  
See product data sheets and detailed information

## Dry screed element (Fermacell 25 mm) with aluminium profiles

Heat output diagram TECEfloor dry-wall construction system TP 30/16 (with aluminium profiles)

Load distribution layer: Dry screed element  $s_{\ddot{u}} = 25 \text{ mm}$ , with  $\lambda_{\ddot{u}} = 0.28 \text{ W/mK}$

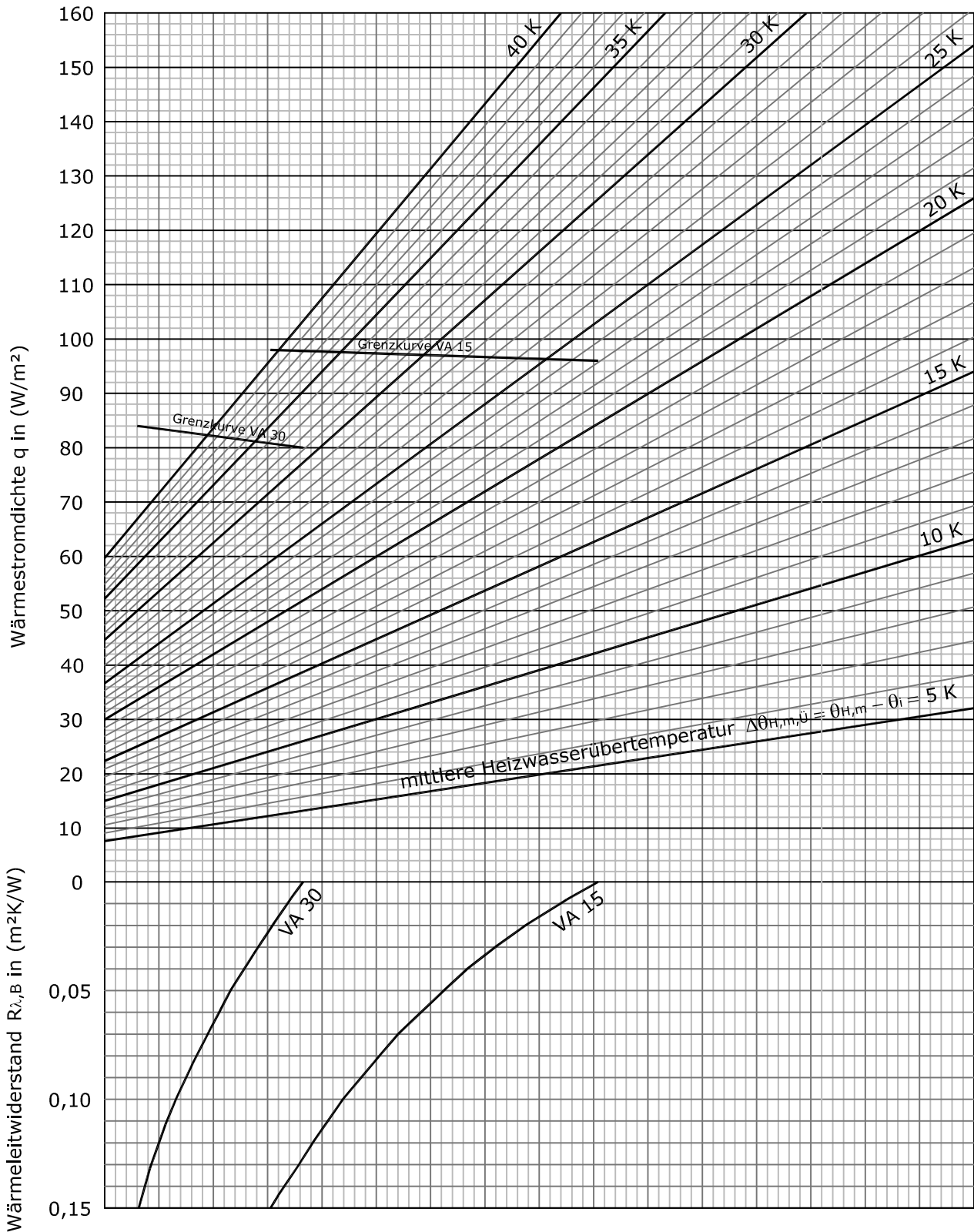

Construction: TE25 TP  
See product data sheets and detailed information



## Dry screed element (Fermacell 25 mm) with steel profiles

Quick design table TECEfloor dry-wall construction system TP 30/16 (with steel profiles)

Load distribution layer: Dry screed element  $s_{\ddot{u}} = 25$  mm, with  $\lambda_{\ddot{u}} = 0.28$  W/mK

Mean heating water temperature				30 °C			35 °C		
Thermal resistance	Room temperature	Spacing	Heating pipe requirement	Max. heat flux density	Mean surface temperature	Max. heating circuit area	Max. heat flux density	Mean surface temperature	Max. heating circuit area
R <sub>I,B</sub>	t <sub>i</sub>	VA	L	q	t <sub>o</sub>	Dim. 16	q	t <sub>o</sub>	Dim. 16
m <sup>2</sup> K/W	°C	(cm)	(m)	(W/m <sup>2</sup> )	(°C)	(m <sup>2</sup> )	(W/m <sup>2</sup> )	(°C)	(m <sup>2</sup> )
0.01	20 °C	15	6.6	34	23.1	29.9	51	24.7	22.8
		30	3.3	19	21.8	55.5	28	22.6	42.9
	24 °C	15	6.6	21	25.9	41.1	38	27.5	27.8
		30	3.3	12	25.1	75.0	21	25.9	51.9
0.05	20 °C	15	6.6	30	22.8	32.4	45	24.2	24.9
		30	3.3	17	21.6	59.7	26	22.4	45.0
0.10	20 °C	15	6.6	26	22.4	35.7	39	23.6	27.3
		30	3.3	16	21.5	62.1	24	22.2	47.4
0.15	20 °C	15	6.6	24	22.2	37.5	35	23.2	29.3
		30	3.3	15	21.4	64.8	22	22.0	50.4

Mean heating water temperature				40 °C			45 °C		
Thermal resistance	Room temperature	Spacing	Heating pipe requirement	Max. heat flux density	Mean surface temperature	Max. heating circuit area	Max. heat flux density	Mean surface temperature	Max. heating circuit area
R <sub>I,B</sub>	t <sub>i</sub>	VA	L	q	t <sub>o</sub>	Dim. 16	q	t <sub>o</sub>	Dim. 16
m <sup>2</sup> K/W	°C	(cm)	(m)	(W/m <sup>2</sup> )	(°C)	(m <sup>2</sup> )	(W/m <sup>2</sup> )	(°C)	(m <sup>2</sup> )
0.01	20 °C	15	6.6	68	26.3	18.9	83	27.7	16.5
		30	3.3	38	23.5	34.8	47	24.4	30.3
	24 °C	15	6.6	54	29.0	22.1	71	30.6	18.3
		30	3.3	31	26.9	39.9	40	27.7	33.8
0.05	20 °C	15	6.6	60	25.6	20.6	74	26.9	17.7
		30	3.3	34	23.1	37.5	42	23.9	32.7
0.10	20 °C	15	6.6	53	24.9	22.2	64	25.9	19.7
		30	3.3	32	23.0	39.3	38	23.5	34.9
0.15	20 °C	15	6.6	47	24.4	24.2	58	25.4	21.0
		30	3.3	30	22.8	40.8	37	23.4	35.5

Max. heating circuit area (plus 2 x 5 m connection line) applicable for  $\Delta T = 10$  K (t<sub>v</sub>-t<sub>r</sub>) and  $D_p = 200$  mbar (including distributor).

Max. surface temperatures according to DIN EN 1264

Living zones: 29 °C/edge zones (max. 1 m): 35 °C | Bathrooms: 33 °C



Construction: TE25 TP  
See product data sheets and detailed information

## Dry screed element (Fermacell 25 mm) with steel profiles

Heat output diagram TECEfloor dry-wall construction system TP 30/16 (with steel profiles)  
 Load distribution layer: Dry screed element  $s_{\ddot{u}} = 25$  mm, with  $\lambda_{\ddot{u}} = 0.28$  W/mK

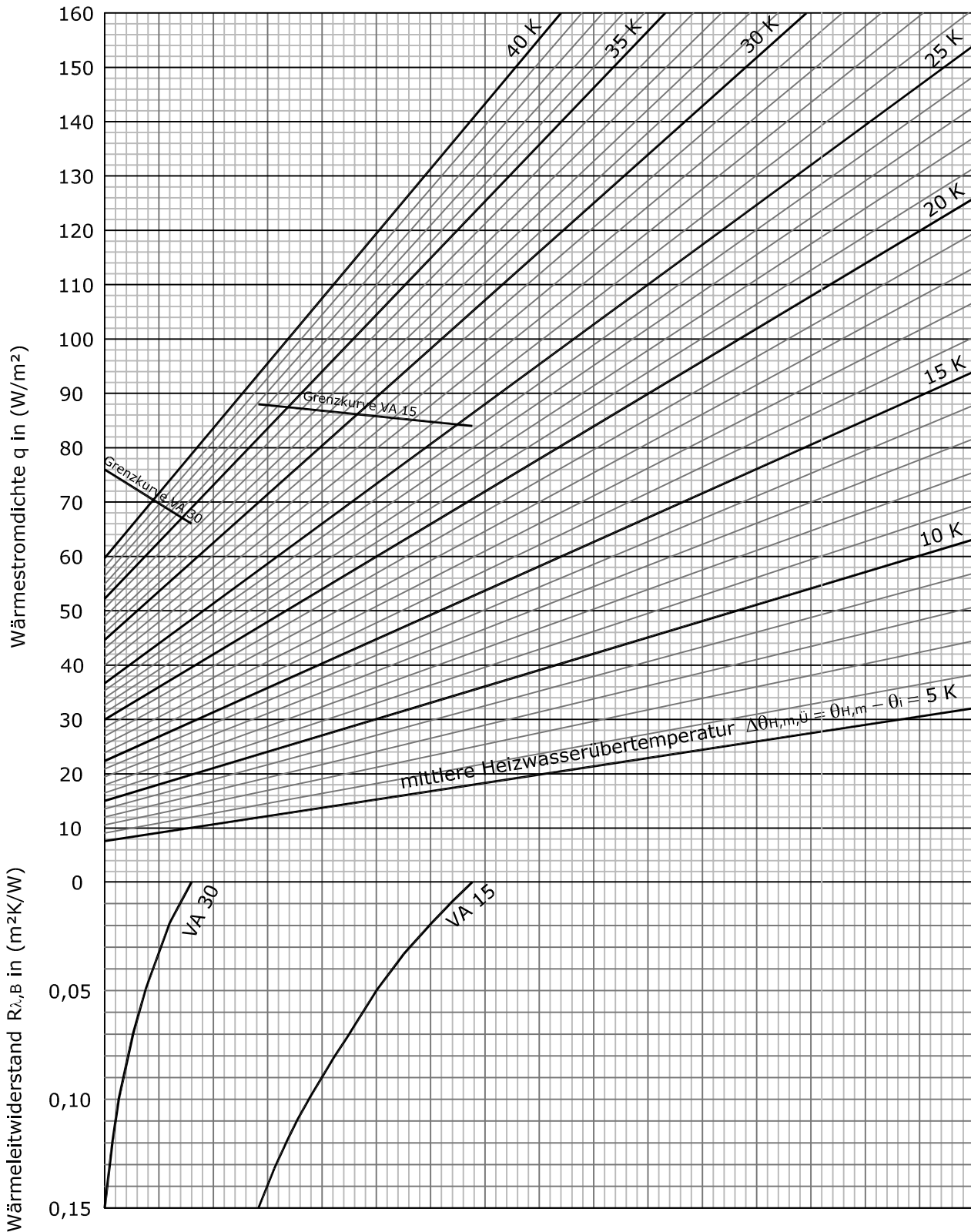

Construction: TE25 TP  
 See product data sheets and detailed information



## Cement screed 30 mm + TECEfloor screed additive Special with aluminium profiles

Quick design table TECEfloor dry-wall construction system TP 30/16 (with aluminium profiles)

Load distribution layer: Cement screed + TECEfloor screed additive Special sü = 30 mm

Mean heating water temperature				30 °C			35 °C		
Thermal resistance	Room temperature	Spacing	Heating pipe requirement	Max. heat flux density	Mean surface temperature	Max. heating circuit area	Max. heat flux density	Mean surface temperature	Max. heating circuit area
RI,B	ti	VA	L	q	to	Dim. 16	q	to	Dim. 16
m <sup>2</sup> K/W	°C	(cm)	(m)	(W/m <sup>2</sup> )	(°C)	(m <sup>2</sup> )	(W/m <sup>2</sup> )	(°C)	(m <sup>2</sup> )
0.01	20°C	15	6.6	61	25.6	20.3	90	28.3	15.6
		30	3.3	38	23.5	34.8	56	25.2	27.0
	24°C	15	6.6	37	27.4	28.2	67	30.2	16.4
		30	3.3	23	26.1	48.9	41	27.8	33.0
0.05	20°C	15	6.6	47	24.4	24.0	70	26.5	18.5
		30	3.3	31	22.9	39.9	46	24.3	30.6
0.10	20°C	15	6.6	37	23.4	28.2	55	25.1	21.8
		30	3.3	26	22.4	45.0	38	23.5	34.8
0.15	20°C	15	6.6	30	22.8	32.4	45	24.2	24.8
		30	3.3	22	22.0	50.4	33	23.1	38.4

Mean heating water temperature				40 °C			45 °C		
Thermal resistance	Room temperature	Spacing	Heating pipe requirement	Max. heat flux density	Mean surface temperature	Max. heating circuit area	Max. heat flux density	Mean surface temperature	Max. heating circuit area
RI,B	ti	VA	L	q	to	Dim. 16	q	to	Dim. 16
m <sup>2</sup> K/W	°C	(cm)	(m)	(W/m <sup>2</sup> )	(°C)	(m <sup>2</sup> )	(W/m <sup>2</sup> )	(°C)	(m <sup>2</sup> )
0.01	20 °C	15	6.6	121	31.2	12.8	148	33.7	11.1
		30	3.3	75	26.9	21.9	92	28.5	19.2
	24 °C	15	6.6	97	33.0	14.7	126	35.7	12.3
		30	3.3	60	29.6	25.8	78	31.2	21.3
0.05	20 °C	15	6.6	94	28.7	15.0	115	30.6	13.2
		30	3.3	62	25.7	24.9	76	27.0	21.6
0.10	20 °C	15	6.6	74	26.9	17.7	91	28.4	15.5
		30	3.3	51	24.7	28.5	62	25.7	24.9
0.15	20 °C	15	6.6	61	25.6	20.3	74	26.9	17.7
		30	3.3	44	24.1	32.1	53	24.9	27.9

Max. heating circuit area (plus 2 x 5 m connection line) applicable for DT = 10 K (tV-tR) and Dp = 200 mbar (including distributor).

Max. surface temperatures according to DIN EN 1264

Living zones: 29 °C/edge zones (max. 1 m): 35 °C | Bathrooms: 33 °C



Construction: CT30 TP  
See product data sheets and detailed information



## Cement screed 30 mm + TECEfloor screed additive Special with aluminium profiles

Heat output diagram TECEfloor dry-wall construction system TP 30/16 (with aluminium profiles)

Load distribution layer: Cement screed + TECEfloor screed additive Special sü = 30 mm

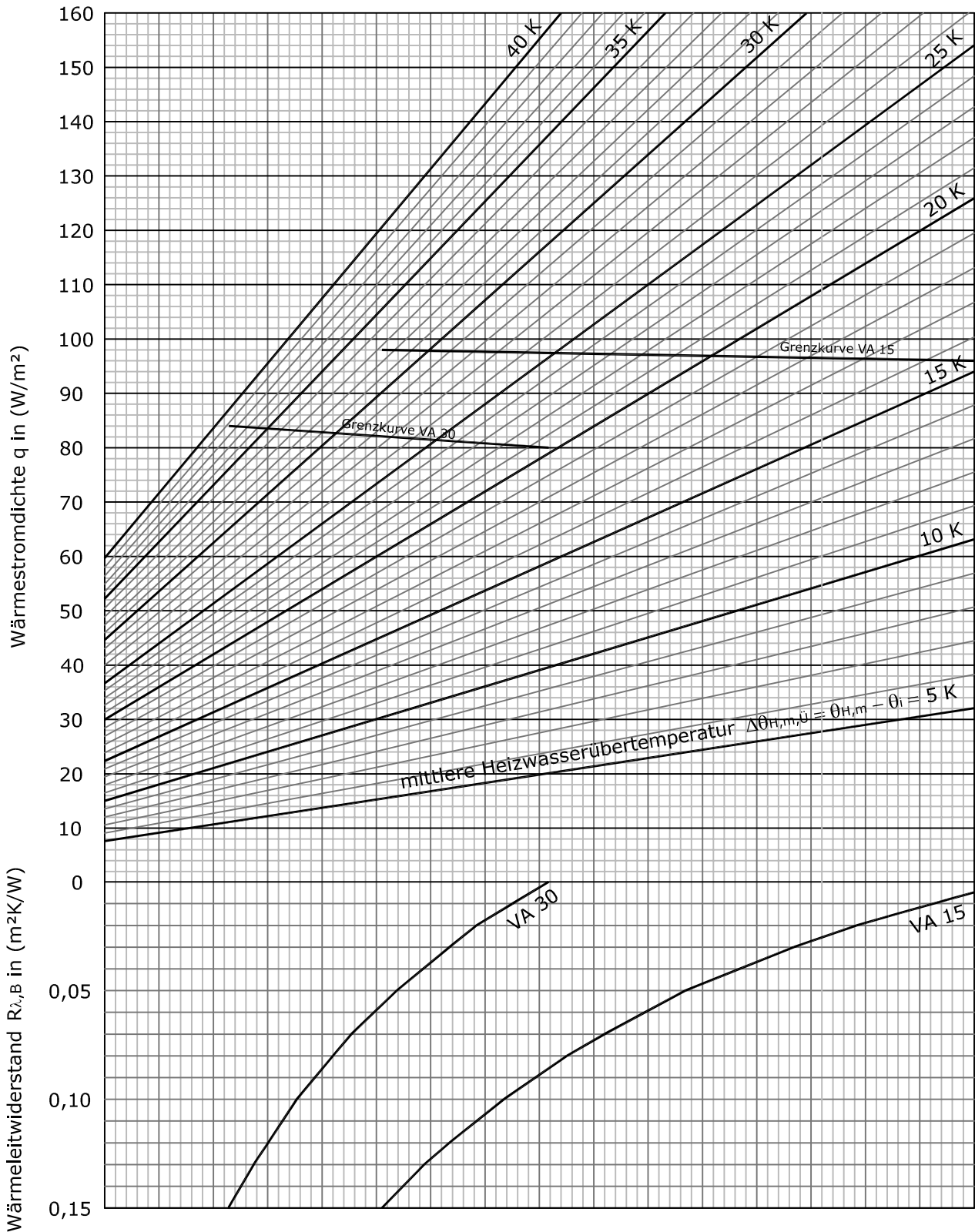

Construction: CT30 TP  
 See product data sheets and detailed information



## Cement screed 30 mm + TECEfloor screed additive Special with steel profiles

Quick design table TECEfloor dry-wall construction system TP 30/16 (with steel profiles)  
Load distribution layer: Cement screed + TECEfloor screed additive Special  $s_{\bar{u}} = 30$  mm

Mean heating water temperature				30 °C			35 °C		
Thermal resistance	Room temperature	Spacing	Heating pipe requirement	Max. heat flux density	Mean surface temperature	Max. heating circuit area	Max. heat flux density	Mean surface temperature	Max. heating circuit area
R <sub>I,B</sub>	t <sub>i</sub>	VA	L	q	t <sub>o</sub>	Dim. 16	q	t <sub>o</sub>	Dim. 16
m <sup>2</sup> K/W	°C	(cm)	(m)	(W/m <sup>2</sup> )	(°C)	(m <sup>2</sup> )	(W/m <sup>2</sup> )	(°C)	(m <sup>2</sup> )
0.01	20 °C	15	6.6	54	25.0	21.9	80	27.4	16.7
		30	3.3	26	22.4	45.0	38	23.5	34.8
	24 °C	15	6.6	33	27.1	30.5	60	29.6	20.4
		30	3.3	16	25.5	62.1	28	26.6	36.9
0.05	20 °C	15	6.6	43	24.0	25.5	64	25.9	19.5
		30	3.3	22	22.0	50.4	33	23.1	38.4
0.10	20 °C	15	6.6	35	23.2	29.3	52	24.8	22.5
		30	3.3	20	21.9	53.7	29	22.7	42.0
0.15	20 °C	15	6.6	28	22.6	33.9	42	23.9	25.8
		30	3.3	17	21.6	59.4	26	22.4	45.0

Mean heating water temperature				40 °C			45 °C		
Thermal resistance	Room temperature	Spacing	Heating pipe requirement	Max. heat flux density	Mean surface temperature	Max. heating circuit area	Max. heat flux density	Mean surface temperature	Max. heating circuit area
R <sub>I,B</sub>	t <sub>i</sub>	VA	L	q	t <sub>o</sub>	Dim. 16	q	t <sub>o</sub>	Dim. 16
m <sup>2</sup> K/W	°C	(cm)	(m)	(W/m <sup>2</sup> )	(°C)	(m <sup>2</sup> )	(W/m <sup>2</sup> )	(°C)	(m <sup>2</sup> )
0.01	20 °C	15	6.6	108	30.0	13.7	132	32.2	11.9
		30	3.3	50	24.6	28.8	62	25.7	24.9
	24 °C	15	6.6	86	32.0	15.9	113	34.5	13.4
		30	3.3	40	27.7	33.6	53	28.9	27.9
0.05	20 °C	15	6.6	86	28.0	16.1	106	29.8	14.0
		30	3.3	44	24.1	31.5	55	25.1	27.0
0.10	20 °C	15	6.6	69	26.4	18.6	84	27.8	16.4
		30	3.3	39	23.6	34.2	47	24.4	30.3
0.15	20 °C	15	6.6	57	25.3	21.2	70	26.5	18.5
		30	3.3	34	23.1	37.5	42	23.9	32.4

Max. heating circuit area (plus 2 x 5 m connection line) applicable for DT = 10 K (t<sub>v</sub>-t<sub>r</sub>) and D<sub>p</sub> = 200 mbar (including distributor).

Max. surface temperatures according to DIN EN 1264

Living zones: 29 °C/edge zones (max. 1 m): 35 °C | Bathrooms: 33 °C



Construction: CT30 TP  
See product data sheets and detailed information

## Cement screed 30 mm + TECEfloor screed additive Special with steel profiles

Heat output diagram TECEfloor dry-wall construction system TP 30/16 (with steel profiles)  
 Load distribution layer: Cement screed + TECEfloor screed additive Special  $s_{\ddot{u}} = 30$  mm

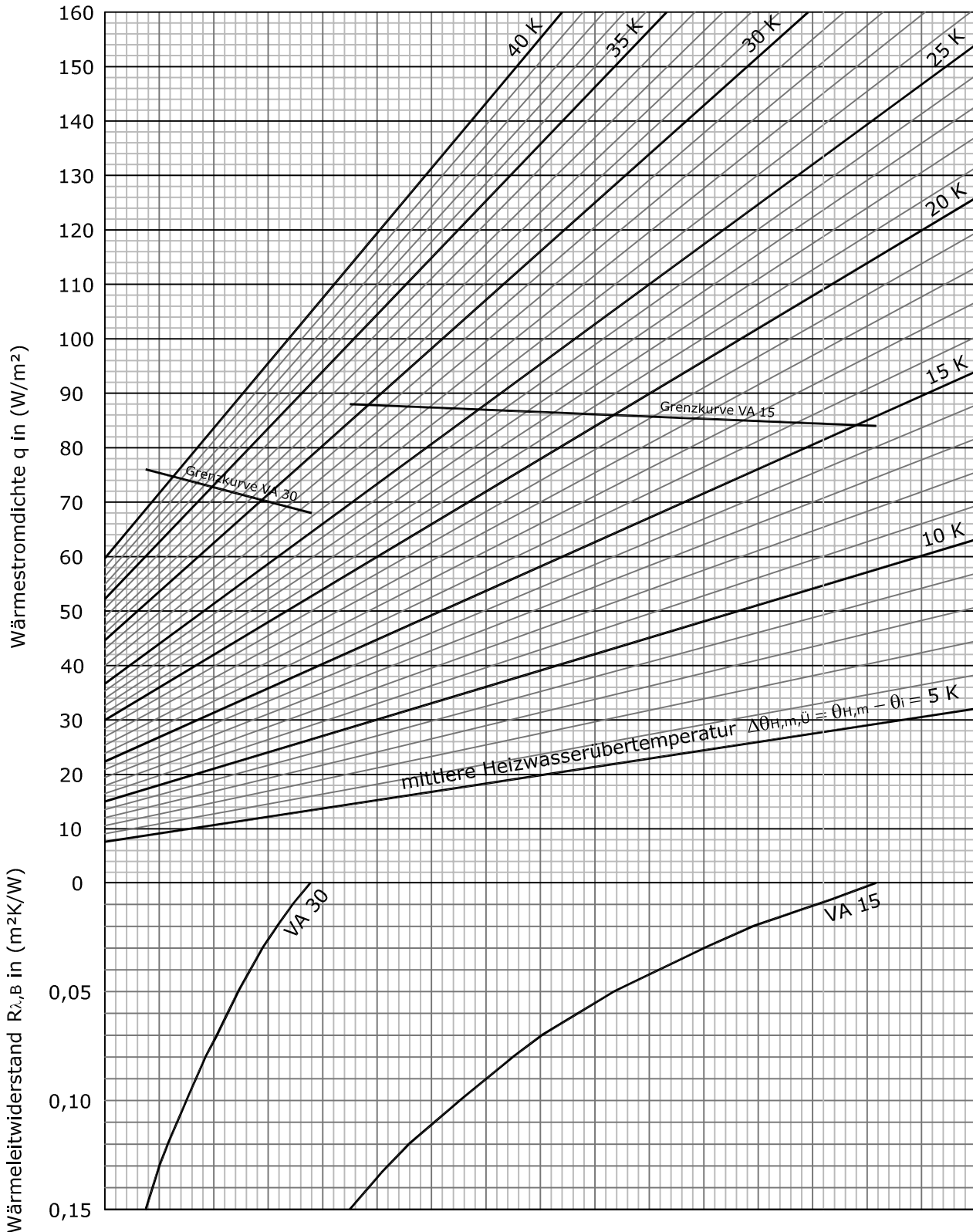

Construction: CT30 TP  
 See product data sheets and detailed information

# Installation instructions dry-wall panel TP 30/16

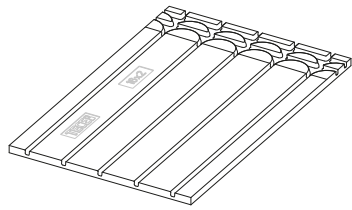

77520006



77520007  
(0,4 mm)

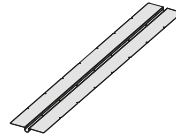

77520008  
(Al - 0,45 mm)

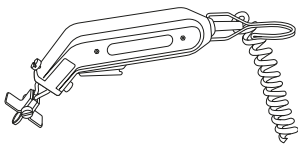

(77520021)

TECEfloor Technische Informationen lesen!  
Read TECEfloor Technical Information!

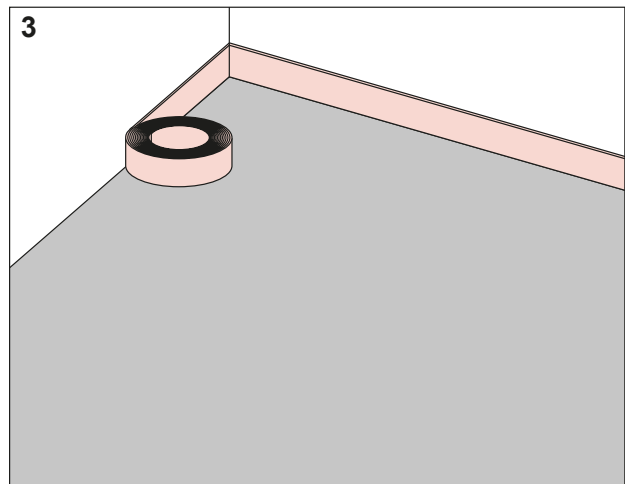
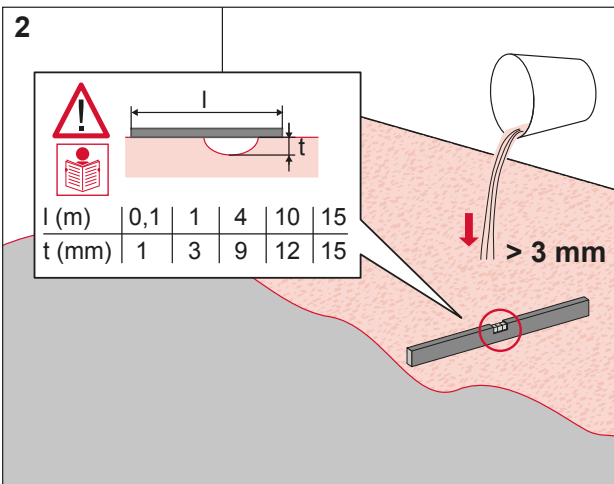
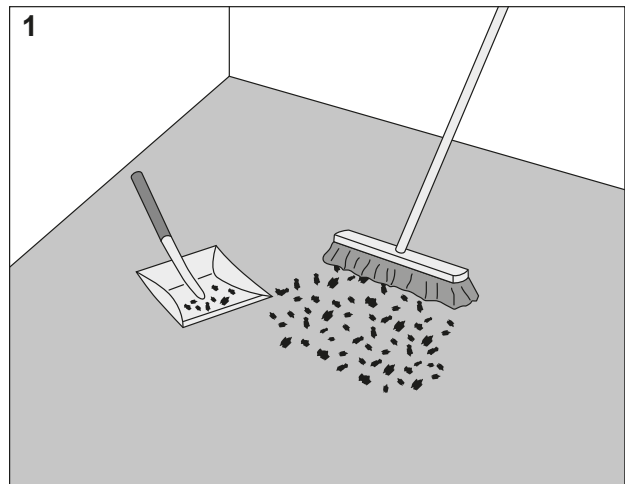
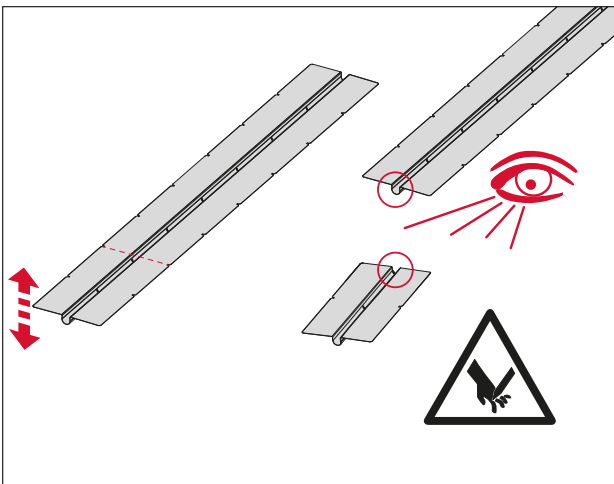

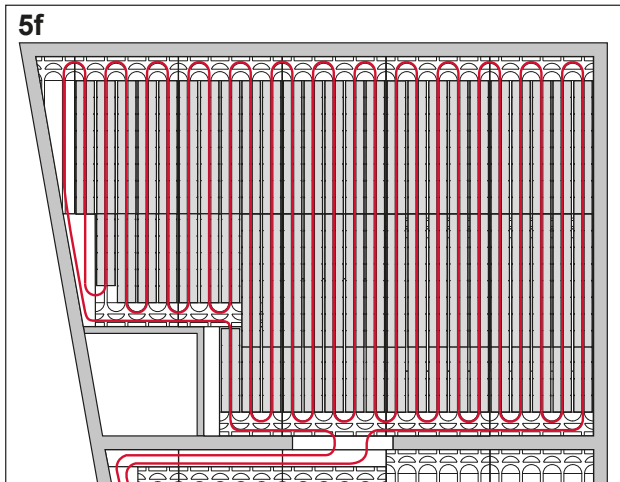
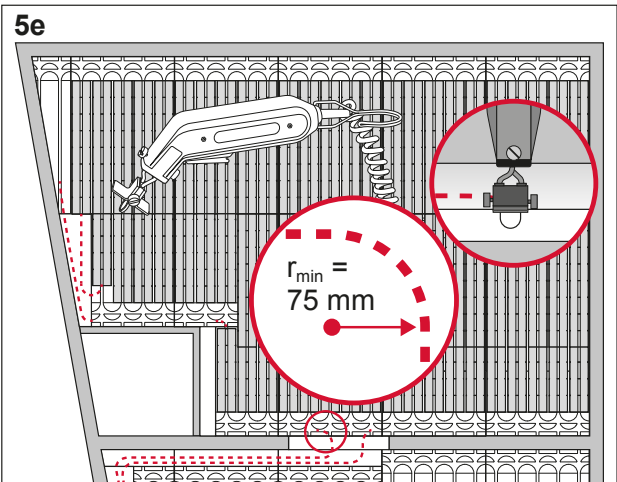
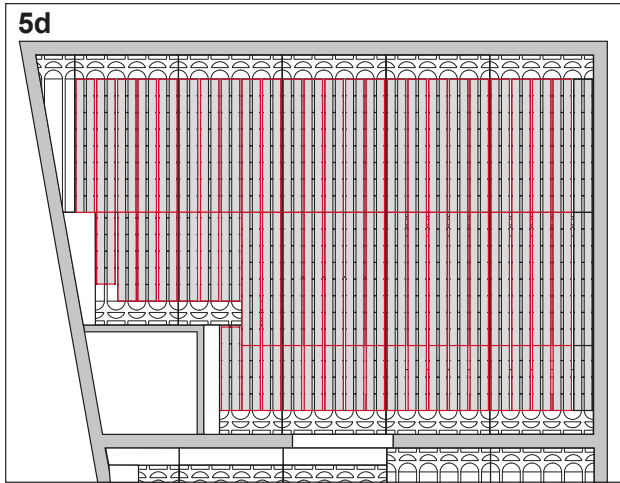
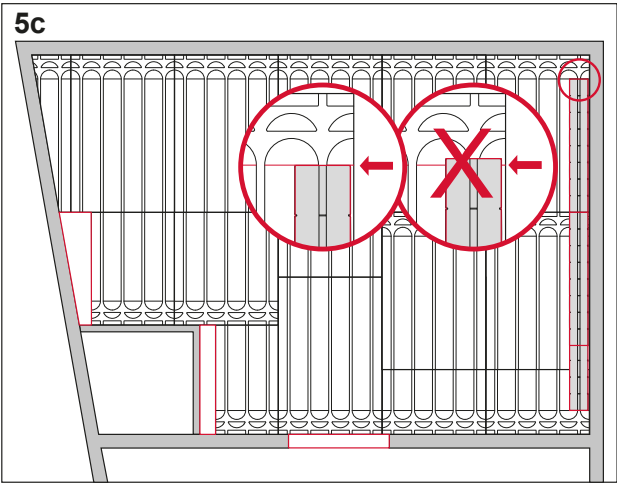
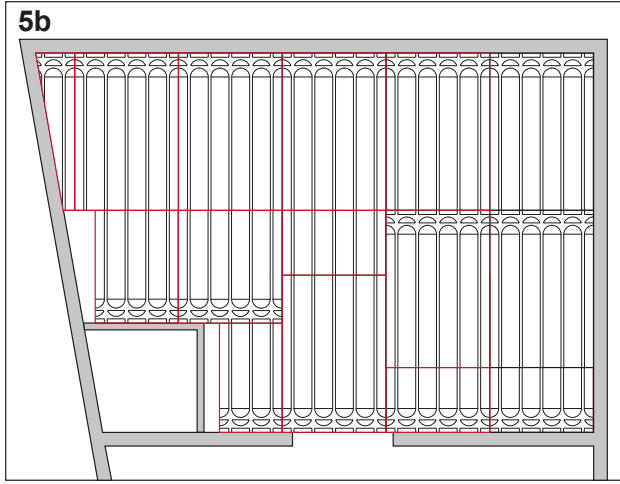
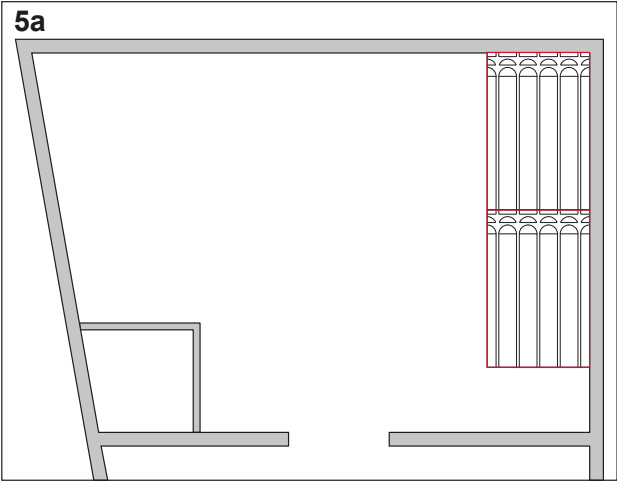

Installation instructions dry-wall panel TP 30/16

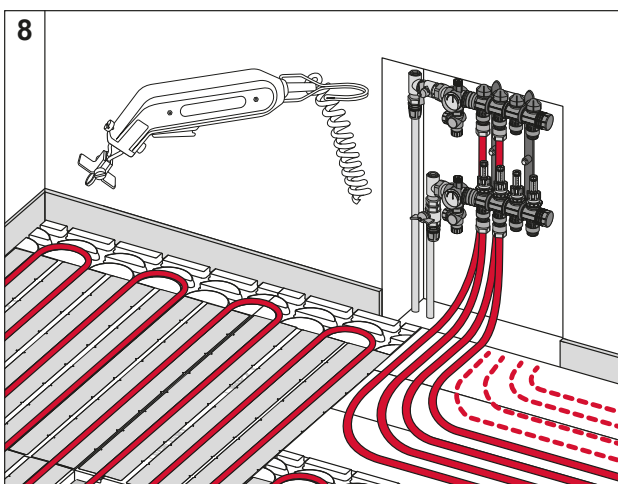
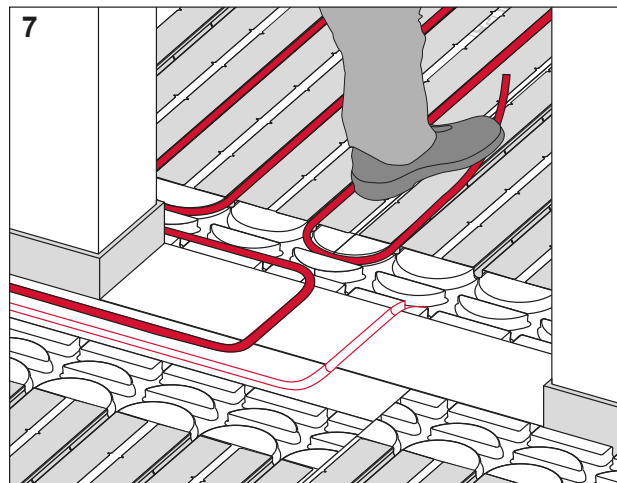
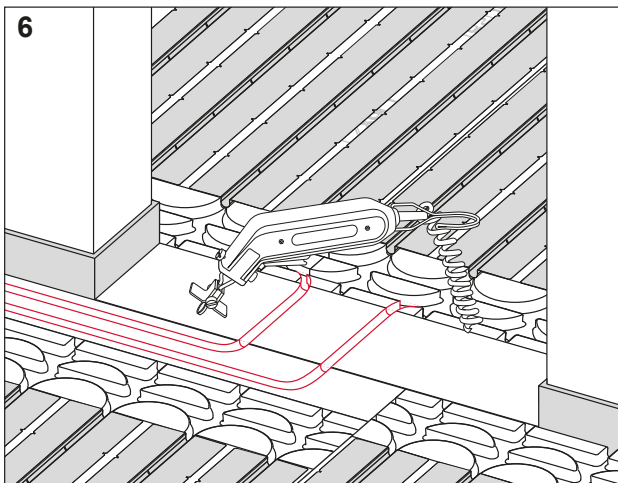

Installation instructions dry-wall panel TP 30/16





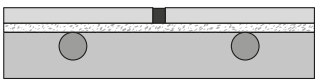

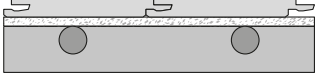

Weitere Fußbodenaufbauten entnehmen Sie bitte den Technischen Informationen TECEfloor.



Further floor constructions please see Technical Information TECEfloor.





• • •



